

EXPERIMENTAL INVESTIGATION OF FORCED CONVECTION HEAT TRANSFER FROM OUTER SURFACE OF ANNULAR TUBE WITH ROTATING INNER TUBE

بحث عملي لإنتقال الحرارة بالحمل الجبري من السطح الخارجي لأنبوب حلقي أنبويه الداخلي دوار

Y. E. Abdel-Ghaffar, Ahmed. A. Sultan

Mech. Power Eng. Dept., Faculty of Engineering

Mansoura University, Egypt.

Email: yeghaffar@mans.edu.eg

الخلاصة:

هذا البحث يدرس انتقال الحرارة بالحمل الجبري الرقائقي لماء ينساب خلال حيز حلقي أسطواني. الأنبوب الداخلي يدور بسرعة تتراوح بين 100 و 628 لفة/ دقيقة لتعطي رقم رينولدز مماسي يتراوح بين 2000 و 29400. القطر الخارجي للأنبوب الحلقي ذو قيمة ثابتة تساوي 54.4 مم بينما يتغير القطر الداخلي ليأخذ ثلاث قيم هي 21.1 ، 33.4 و 48.1 مم وذلك للحصول على نسبة أقطار تساوي 0.3879 ، 0.614 و 0.8842. ينساب الماء في الحيز الحلقي بسرعات تتغير من 0.0014 إلى 0.37 م/ث لتسمح بتغير رقم رينولدز المحوري من 80 إلى 2700. لينطى النطاق الرقائقي. يتم تبريد الأنبوب الخارجي للحيز الحلقي تحت درجة حرارة منتظمة باستخدام دائرة تبريد تعمل بفرغون 22 في حين أن الأنبوب الداخلي معزول حرارياً. تم في هذا البحث دراسة تأثير كل من نسبة الأقطار للحيز الحلقي ورقم رينولدز المحوري ورقم رينولدز المماسي على معاملات انتقال الحرارة (رقم نوسلت).

وقد بينت للتجارب العملية في هذا البحث أن معامل انتقال الحرارة للحيز الحلقي الدوار كما للحيز الحلقي الساكن يزداد بزيادة نسبة الأقطار لنفس رقم رينولدز المحوري والمماسي. بينت النتائج أيضاً أن معامل انتقال الحرارة للحيز الحلقي الدوار أعلى من نظيره للحيز الحلقي الساكن عند نفس القيم لنسبة الأقطار ولرقم رينولدز المحوري. تبين من النتائج أيضاً أنه توجد قيمة عظمى لمعامل انتقال الحرارة عند رقم رينولدز مماسي يساوي 12725 تقريباً (سرعة دوران تساوي 270 لفة/ دقيقة تقريباً). هناك زيادة قصوى في انتقال الحرارة خلال الحيز الحلقي الدوار ذو نسبة أقطار 0.8842 عند سرعة دوران تساوي 270 لفة/ دقيقة تصل إلى 44% بالمقارنة بنتائج الحيز الحلقي الساكن عند نفس رقم رينولدز المحوري. تم صياغة النتائج في صورة معادلة بين رقم نوسلت وكل من نسبة الأقطار ، رقم رينولدز المحوري ورقم رينولدز المماسي.

Abstract

The paper presents an experimental study of laminar forced convection heat transfer in different rotational isothermal annular tubes. The inner tube of the annulus is rotated with rotational speeds varies from 100 to 628 r.p.m to give rotational Reynolds number in the range $2000 \leq Re_m \leq 29400$. The inner tube of the annulus is varied so as to give radii ratios of 0.3879, 0.614 and 0.8842. Water is flowed axially through the annular space with velocities ranged from 0.00414 to 0.27 m/s to give axial Reynolds number in the range $80 \leq Re_n \leq 2700$ to cover the laminar flow regime. The outer tube of the annulus is cooled under uniform temperature via the evaporation of refrigerant R 22 flowing through a refrigeration circuit while the inner tube of the annulus is thermally insulated. In the present work the effect of radius ratio, axial Reynolds number and rotational Reynolds number on the heat transfer are subjects of major interest.

The experimental results of this work show that the heat transfer of the rotational as well as the stationary annular tubes increase with the increase of the radius ratio of the annulus. The results show also that heat transfer of the rotational annular tubes is higher than this of the stationary ones at the same radius ratio and axial Reynolds number. There are peak values of heat transfer at a rotational Reynolds number of nearly 12725 (rotational speed of 270 rpm nearly) for different radius ratio of the annulus. An increase as much as 44 % in the heat transfer is reported for annular tube of radius ratio of 0.8842 and rotational speed of 270 rpm. Excellent correlation is established between Nusselt number and axial Reynolds number, rotational Reynolds number and radius ratio of the annulus for both rotational and stationary annular tubes.

Keywords: Laminar forced convection, heat transfer, annular tube, rotating inner tube, radius ratio

Nomenclature

A	Surface area, m ²	K	Thermal conductivity, W/m K
A _c	Cross section area, m ²	L	Test section length, m
C _p	Specific heat at constant pressure, J/kg.K	m	water mass flow rate, kg/s
d _i	Annulus inner diameter, m	n	No. of thermocouples
d _o	Annulus outer diameter, m	P	Pressure, Pa
d _h	Hydraulic diameter, m	Q	Heat transfer rate, W
g	Gravitational acceleration, m/s ²	q	Heat flux, W/m ²
h	Convective heat transfer coefficient, W/m ² K	T	Temperature, K
N	Rpm of the rotating inner annulus	u	Average velocity, m/s
		v	tangential velocity, m/s

Dimensionless Groups

Nu Nusselt number

Pr Prandtl number

Re Reynolds number

Greek letters

ν Kinematic viscosity, m²/s

ω Angular velocity, rad/s

Subscripts

c Cross-sectional area

d Based on annulus outer diameter

e Exit

h Based on hydraulic diameter

I Inner

o Outer

s wall

w_i Inlet water

w_o Outlet water

ω Based on angular velocity

1. Introduction

Several forms of rotating flows present themselves in chemical and mechanical mixing and separation devices, electrical and turbomachinery, combustion chambers, pollution control devices, swirl nozzles, rocketry, fusion reactors and in atmospheric and geophysical phenomena. Rotation of the flow in these examples can be induced through boundary motion, as an initial swirl, or through the action of body force field.

The straight axial flow with no boundary rotation and the inner cylinder rotation with no axial flow constitutes the two limiting cases of annular flow heat transfer studies. There exists a large body of work in the literature associated with both

categories. A representative list of the former category includes references, [1-4]. The last one authored by Kays and Leung is perhaps the most comprehensive treatment of the straight annular flow heat transfer. In that work, the authors presented an analytic solution complemented by extensive experimental data. Also, an empirical relationship in the form $Nu = 0.022 Re^{0.8} Pr^{0.5}$ is proposed to fit the experimental data.

Heat transfer in an annulus with inner cylinder rotation, but in the absence of an axial "carrier" was studied in references [5-8]. These studies established the various possible flow regimes in the annulus and their stability limits as a function of the rotational Taylor number. Four flow regimes were recognized: laminar, laminar with

taylor vortices, turbulent with taylor vortices and fully turbulent regimes. The heat transfer studies referenced previously spanned all the four regimes. For the fully turbulent case the Nusselt is correlated with the rotational Taylor number as follows [7]:

$$Nu = 0.409(T_a)_m^{0.241}$$

Here T_a is a modified Taylor number, the conventional rotational Taylor number devices by a complicated radius ratio geometric factor [5].

The mixed mode case with inner cylinder in rotation in the presence of axial flow was studied by Luke (9) in connection with the cooling of the electric motors. This work was later expanded by Gazley [10] who inferred from this data and those of Luke's, the form $Nu \sim (Re)_{eff}^{0.8}$. In this relationships Re was constructed by an effective velocity defined as:

$$v_{eff} = \left[u^2 + \left(\frac{v}{2} \right)^2 \right]^{1/2} \quad (1)$$

Tachibana and Fukui [11] did similar work to Gazley's and, again, using Gasley's effective velocity for the narrow gap annulus offered a heat transfer correlation in the form:

$$Nu = 0.015 \left(1 + 2.3 \frac{D_H}{L} \left(\frac{D_o}{D_i} \right)^{0.45} \right) (Re)_{eff}^{0.8} Pr^{1/3} \quad (2)$$

In this equation L is the test section length and short section used in the experiments warranted inclusion of the entrances effect.

Molozen and polyak [12] reviewed the work of references [9-11]. They proposed a lengthy expression for Nusselt number, which spans the two limiting cases of pure rotational and pure axial, fully turbulent heat transfer in annuli with arbitrary gap ratio.

The present work attempts to fill a gap in the annular flow heat transfer. This is

the case of different radii ratio, comparatively small speed of rotation, long, annular channel with laminar axial flow in the presence of inner cylinder rotation. The rotation speed is varied from 100 to 628 rpm.

2. Experimental Facility

The experimental facility used to study the forced convection flows through the horizontal annular tube is designed to encompass as wide range of the relevant parameters as possible, so that a systematic investigation of the effect of both the axial flow and rotational speed (centrifugal forces) on the overall heat transfer can be carried out.

A schematic diagram showing the major components of the experimental facility is shown in fig (1). The individual components can be loosely divided into three systems:

1- The actual test section, 2- the drive mechanism and 3- the refrigeration circuits and will be discussed below.

The actual test section is composed mainly of an outer annular shell (6) and a rotor (9) as shown in Fig (1). The annular shell is made of two galvanized steel tubes with inner and outer diameters of 54.4 and 60.33 mm for the inner tube and 78.08 and 88.9 mm for the outer one. The two tubes of the shell are assembled coaxially via two steel flanges (4) by welding so that the inner diameter of the flanges equals the inner diameter of the inner tube of the annular shell. The two flanges also serve as seals for the test section. Four holes are drilled in each flange at a pitch circle diameter of 69.0 mm for the sake of assembly. Two copper tubes diameter 6.0 mm are welded on the outer peripheral of the outer tube of the annular shell at the beginning and end of it. These copper tubes are connected to the refrigeration circuit, the evaporator of which is the annular shell itself.

Two other flanges (13, 18) are machined from steel in order to hold the

rotor concentrically with the inner surface of the annular shell and to prevent water leakage from the test section. The left flange (13) is machined so that it has a cylindrical end cup serves as a base of bearing when assembled with one end of the rotor. The right flange (18) is machined to hold a short shaft (16) provided with a ball bearing and O-ring seal in order to allow smooth shaft rotation and prevents water leakage from the test section.

The inside end of the short shaft is machined so as to have an outside diameter equal to the inside diameter of rotor end. The outside end of the short shaft is provided by a keyway in order to hold bully used to transmit motor rotation with variable speed gearbox (20) and v-belt (21).

Due to the substantial machining requirements of the annular shell, only one was constructed and used with each of rotors. The effective length of the test section is 500 mm in all cases. Thus the radii ratios (inner to outer cylindrical gap diameters) are 0.3879, 0.614 and 0.8842.

The rotor (9) of the test section is made of plastic (PVC) pipe of 22.1, 33.4 and 48.1 mm outer diameters. It is provided with a copper short rod (15) laid inside the end cup of the left flange, while the other end is fixed the short shaft by means of a through bolt passing perpendicular to the axis of the rotor.

The drive mechanism is consisted of a 220V, 1/4 kW, 1420 rpm AC electric motor (19) coupled with variable gearbox (20), the motion is transmitted from the gear box shaft to the pulley using a key to achieve the transfer of torque to the rotor via V-belt (21).

The refrigeration circuit consisted mainly of an evaporator and condensing unit. The annular shell of the test section is used directly as the refrigeration circuit

evaporator. The condensing unit (22) type DKSJ-100 Copelend is consisted of a 1.0 kW semi-hermetic compressor working with refrigerant R22, connected to an air-cooled condenser. The circuit is provided also with a receiver and thermostatic expansion valve type TF-0.5 with orifice no. 2 (10) from Danfoss company to control the refrigerant passing through the annular gap of the annular shell.

The surface temperature of the inner cylinder of the annular shell is measured by four thermocouples (8) impeded within the cylinder wall at various axial locations. An additional thermocouple is used to measure the ambient room temperature. Two thermocouples (2) are used to measure water inlet and outlet temperature. Water is drawn from constant level tank (11) through control valve (1) and the flow rate is measured by a calibrated rotameter (12). In order to facilitate water flow through the test section under investigation, two circular disks (14) made of Teflon, 10mm thickness, having the same inner and outer diameter of the flanges welded with the annular shell. Four holes of diameter 5mm distributed equally through the outer peripheral of the disk perpendicular to its axis and provided with four ports connected to the main water intake and discharge through a rubber tubes. These ports are used to insure well distribution of water through the annular gap under test.

The entire arrangement is wounded by a 50 mm fiberglass self-adhesive tape. (7) Thermocouples in the test section are all type K copper constantan. A total of 7 thermocouples were placed in the system and connected to a 12 point self switch temperature recorder type Yokogawa (17) capable of reading up to 200°C with a sensitivity of 0.1°C. The rotational speed can be detected by a photoelectric tachometer

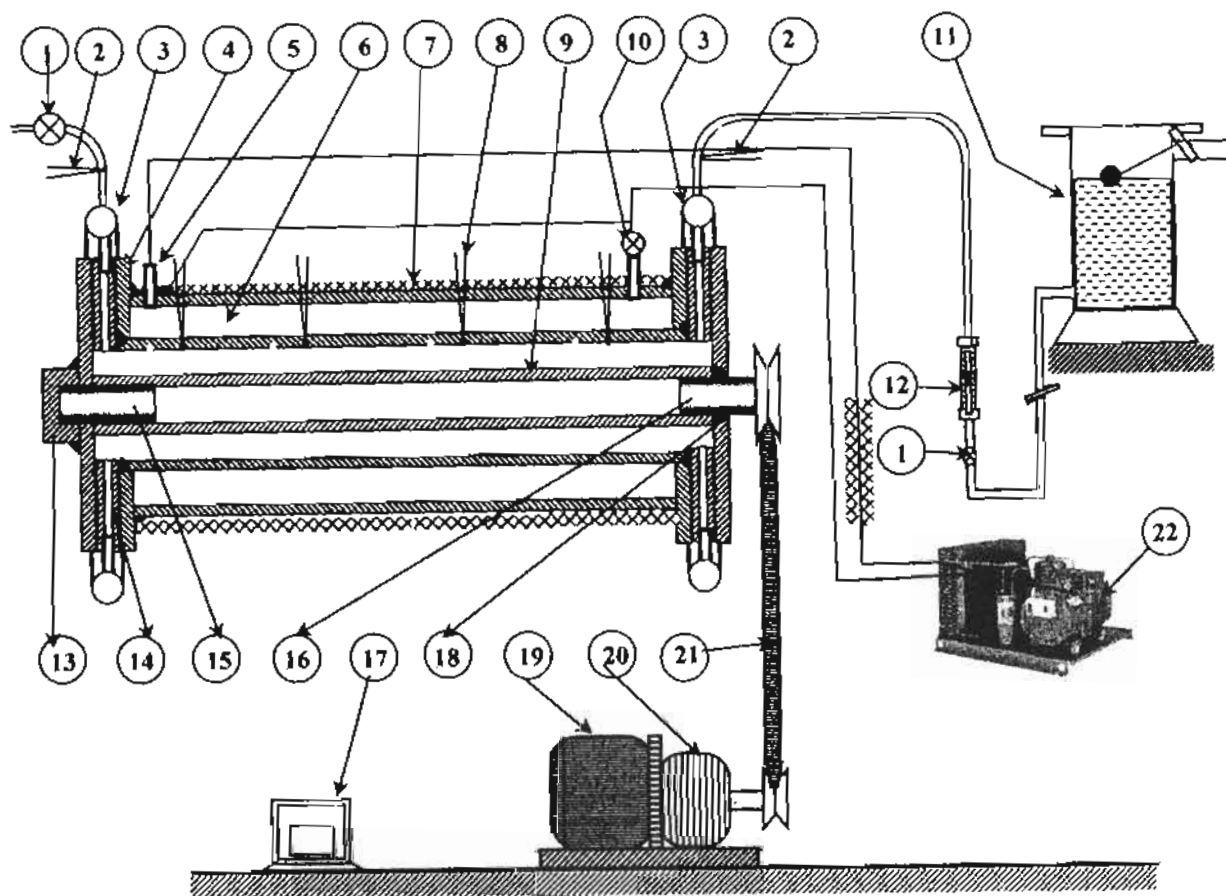

- | | | | |
|------------------------|--------------------------|-----------------------------|---------------------|
| 1- Control valve | 7- Fiberglass insulation | 13- flange with end cup | 19- Electric motor |
| 2- Thermocouple | 8- Thermocouple | 14- Teflon disk | 20- Gearbox |
| 3- Plastic tube | 9- The rotor | 15- copper short rod | 21- V-belt |
| 4- steel flange | 10- Expansion valve | 16- end shaft | 22- Condensing unit |
| 5- copper tube | 11- water tank | 17- Temperature recorder | |
| 6- outer annular shell | 12- Rotameter | 18- flange with O-ring seal | |

Fig. 1 Schematic diagram of experimental set-up

3. Experimental Operation and Procedure

Three input parameters can be varied independently in this system: the speed of rotation of the inner cylinder, the velocity of water flowing through the annular space and gap thickness (inner cylinder diameter). For a given combination of these parameters, the outlet temperature of water will eventually,

reach a certain fixed value, when this value is reached, the system is in a state of equilibrium. These conditions are ascertained by measuring water temperature at selected time intervals and observing any changes. When these changes become small (within $\pm 0.1^\circ\text{C}$), the steady state condition is assumed. For every case studied, the equilibrium time was approximately 30 minutes. To be certain that the values

recorded are representative at the steady-state calibration 30 minutes beyond the transient setting periods and the average of these values is used in subsequent calculations.

Determining the heat transfer results in stationary annular tubes of different radius ratio and comparing them with the

available correlation first standardized the experimental set up. Steady state values of mean Nusselt numbers for uniform temperature cooling of water then determined with each of the different radius ratio of annular tube for different speed of rotation of its inner tube. The characteristics of stationary annular tube as well as rotational one are shown in Table 1.

Table 1 Characteristics of Annular Tubes

Tube Number	d_i mm	d_o mm	d_h mm	L mm	N rpm
1	21.1	54.4	33.3	500	0
2	33.4	54.4	21.0	500	0
3	48.1	54.4	6.30	500	0
4	21.1	54.4	33.3	500	100-628
5	33.4	54.4	21.0	500	100-628
6	48.1	54.4	6.30	500	100-628

4. Flow and Heat Transfer Characteristics

From the detailed constructions of the annular tubes described in Table 1, the cross sectional area of the stationary as well as the rotational annular tubes can be set as:

$$A_c = \frac{\pi}{4}(d_o^2 - d_i^2) \quad (3)$$

The volumetric diameter defined as four times the volume for flow divided by the area of the witted surface was used as the hydraulic diameter (d_h) for the sake of comparison with the available literatures. The hydraulic diameter can be expressed as:

$$d_h = d_o - d_i \quad (4)$$

Based on the hydraulic diameter as a characteristic length, Reynolds number of the annular tubes Re_h can be calculated from:

$$Re_h = \frac{u \times d_h}{\nu} \quad (5)$$

Where u is the mean velocity of water flowing through the annular space. Correspondingly, Nusselt number of the annular tubes Nu_h based on the hydraulic diameter can be written as:

$$Nu_h = \frac{h_o \times d_h}{k} \quad (6)$$

Where h_o is the heat transfer coefficient at the outer surface of the annular tube that can be calculated as follows: The heat transfer rate between Refrigerant R-22 and water flows across the annular space were calculated by:

$$\begin{aligned} Q &= mc_p(T_{wo} - T_{wi}) \\ &= h_o A_o (LMTD) \end{aligned} \quad (7)$$

Where $LMTD$ is the logarithmic mean temperature difference defined as:

$$LMTD = \frac{(T_{wi} - T_s) - (T_{wo} - T_s)}{\ln[(T_{wi} - T_s) / (T_{wo} - T_s)]} \quad (8)$$

Where T_{wi} and T_{wo} are inlet and outlet water temperatures while T_s is the mean wall temperature defined as:

$$T_s = (T_{s1} + T_{s2} + T_{s3} + T_{s4}) / 4 \quad (9)$$

Where T_{s1}, \dots, T_{s4} are the local temperatures of the outer tube of the annulus.

In view of the different values of inner tube diameter and consequently the different values of the hydraulic diameter, the outer diameter of the annulus is used as a characteristic length. Thus Reynolds number as well as Nusselt number of the stationary as well as the rotational annulus based on its outer diameter can be expressed as:

$$Re_d = \frac{u \times d_o}{\nu} \quad (10)$$

$$Nu_d = \frac{h_o \times d_o}{k} \quad (11)$$

The effect of rotational speed of the inner tube may be accounted for by the rotational Reynolds number Re_ω based on the tangential velocity of the rotated tube v and the hydraulic diameter of the annular tube as a characteristic length. Then the rotational Reynolds number can be set as:

$$Re_\omega = \frac{\omega \times d_i d_h}{\nu} \quad (12)$$

Where ω is the angular velocity of the rotating inner tube (rad/sec).

5. Results and Discussion

Laminar forced convection of water flowing through annular tubes having rotational inner tubes is studied experimentally. The outer tube of the annulus is subjected to uniform temperature due to the evaporation of Refrigerant R22 flowing through the outer annular shell used as the evaporator of a refrigeration circuit while the inner wall is insulated. The effect of axial Reynolds number Re_h , Rotational

Reynolds numbers Re_ω , and radii ratios of the annulus tube d_i/d_o on the heat transfer rates are discussed in this section. In the present work radii ratios are equal to 0.3879, 0.614 and 0.8842, axial Reynolds numbers range from 80 to 2700 while the rotational Reynolds numbers range from 2000 to 29400.

5.1. Validation of Experimental Results

Before reporting to the main results of the present work, mention will be made of relevant auxiliary experiments. To demonstrate the validity of the experimental apparatus, heat transfer experiments were performed with three stationary annular tubes in order to enable comparison with heat transfer results in the literature. The relation between Nusselt number and Reynolds number based on the hydraulic diameter of the annular tubes with radii ratios of, 0.3879, 0.614 and 0.8842 are presented in Fig. (2) as well as three straight lines representing the correlation of reference [17] for different radii ratios. It is concluded from the figure that the present experimental results for stationary annular tubes with different radii ratios are in fair agreement with the literature.

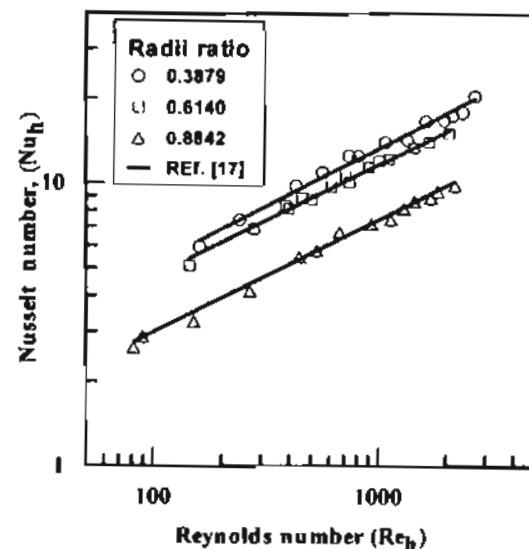

Fig. (2) Nusselt number versus Reynolds number based on hydraulic diameter (d_h) at different radii ratios for stationary annulus.

The diameter of the outside tube of the annulus rather than its hydraulic diameter are used in Nusselt and Reynolds numbers in order to best show the variation obtainable due to the variation of radii ratios. The average Nusselt numbers Nu_d of the stationary annular tubes with radii ratios of 0.3879, 0.614 and 0.8842 are shown in Fig. (3) as functions of axial Reynolds number Re_d . As can be expected the Nusselt number increases with Reynolds number for the same radius ratio. The figure also shows that, the Nusselt number increases with the increase of radius ratio at the same Reynolds number.

5.2 Stationary Annular Tubes Correlation

As seen from Fig (2) the empirical correlation of Ref [17] when represented for different radii ratios gives different straight lines each of them corresponding to a finite radius ratio. From these plots it is easily perceived that relations of the type $Nu_h = c (Re_h)^m$ will represent the experimental data of constant radius ratio.

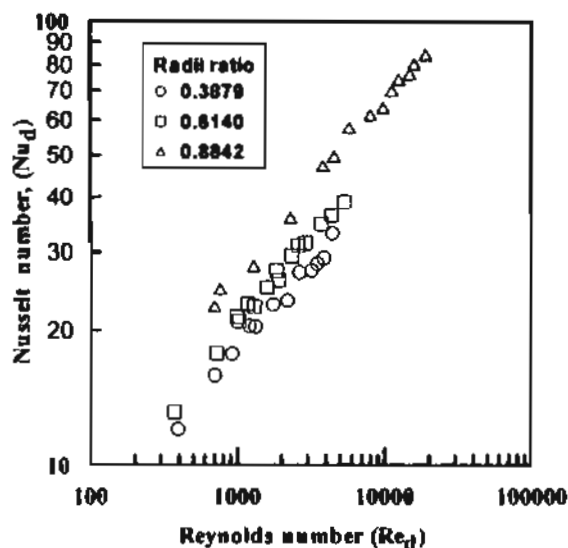

Fig. (3) Nusselt number versus Reynolds number based on annulus outer diameter (d_o) at different radii ratios for stationary annulus.

An empirical correlation was suggested to correlate the data of stationary annular tubes of different radius ratio. A

least square fit of the present experimental data of stationary annular tube covering a wide range of Re_h and different radii ratios gave the following correlation:

$$Nu_h = 1.175 Re_h^{0.4} \{1 + 0.676(d_i/d_o)\} \quad (13)$$

The above correlation is valid for $80 \leq Re_h \leq 2700$, $0.3879 \leq d_i/d_o \leq 0.8842$ and $15 \leq L/D_h \leq 80$ and predicts the values of Nusselt number, which agree with the experimental results within $\pm 8\%$ as shown in Fig (4).

5.3 Rotational Annular tubes Results

Attention will now be turned to the heat transfer results of rotational annular tubes. In this connection the sequence in which the experiments were performed was chosen in order to facilitate the presentation of results. For a specified value of radius ratio (d_i/d_o), successive experiments were carried out with different values of rotational Reynolds number Re_ω one at a time. The axial Reynolds number Re_h was changed for each radii ratio and rotational Reynolds number in order to cover its specified range each time. Therefore three groups of experiments were performed and discussed in the following sections.

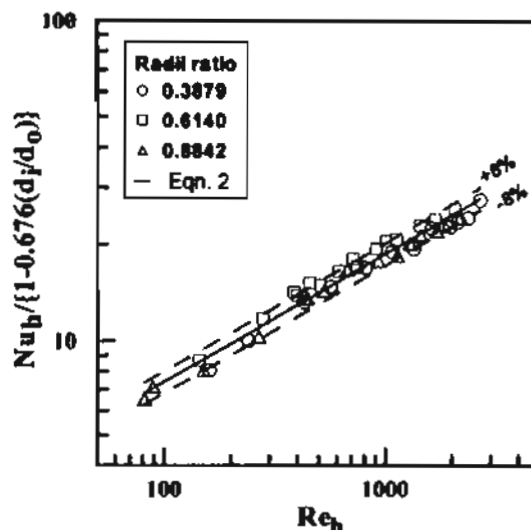

Fig. (4) Representation of general equation of Stationary annular tubes

The heat transfer coefficient at the outer surface of the annular tubes in case of laminar flow of water through the annular space for three different radii ratios were analyzed in terms of $Nu_h - Re_h$ relationships. Figures (5-7) show the variation of Nusselt number Nu_h with Reynolds number Re_h for annulus of radii ratios of 0.3879, 0.614 and 0.8842 respectively. From the over view of these figures it may be concluded that Nusselt number for the rotational annular tubes are higher than those of the stationary ones in spite of the value of radius ratio

Fig (5) shows that for a radius ratio of 0.3879 the rotational speed of nearly 270 rpm ($Re_\omega=11142$ nearly) produce a maximum increase in Nusselt number of about of 40%, whereas the rotational speed of 628 rpm yielded an increase of only 12 % in Nusselt number, compared to the results of the stationary annular tube of the same radius ratio. The same trend can be seen from Figures (6 and 7) with maximum increase in Nusselt numbers of 28% and 44% and minimum increase in Nusselt numbers of 4% and 12% at radii ratios of 0.614 and 0.8842 respectively in comparison with the results of stationary annular tubes with the same radius ratio.

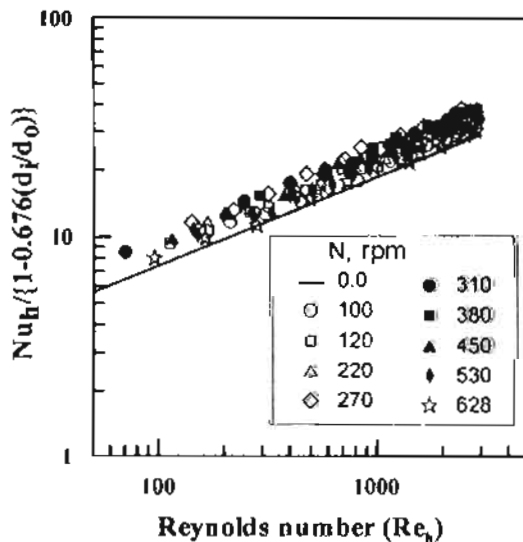

Fig. (5) Relation between Nusselt number and Reynolds number for radii ratio of 0.3879 at different rotational speed.

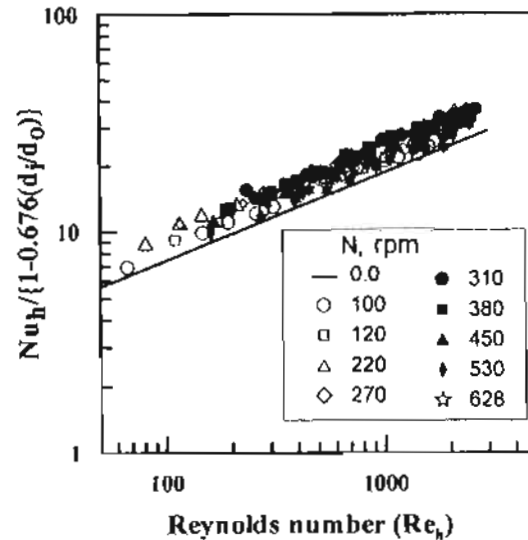

Fig. (6) Relation between Nusselt number and Reynolds number for radii ratio of 0.614 at different rotational speed.

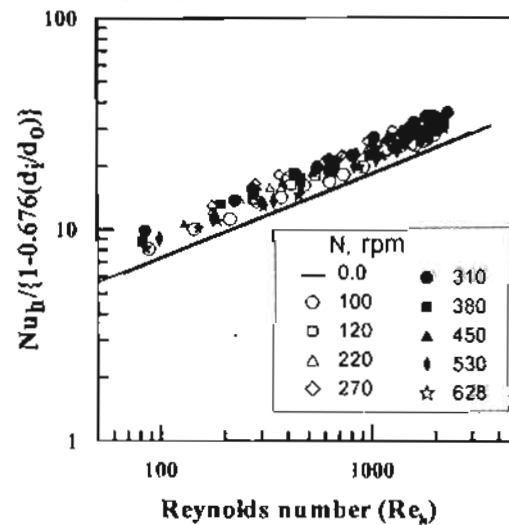

Fig. (7) Relation between Nusselt number and Reynolds number for radii ratio of 0.8842 at different stationary speed.

To clearly show the effect of rotational speed on the heat transfer rate, elimination of the effect of axial Reynolds number and radius ratio has been done. The complex $Nu_h / \{ [1 - 0.676(d_i/d_o)] Re_h^{0.4} \}$ is plotted versus the rotational Reynolds number Re_ω as shown in Fig (8). It is concluded from Fig (8) that the Nusselt number is increased with the increases of the rotational Reynolds number (rotational speed) up to a maximum value at a rotational Reynolds number of nearly

11000 (rotational speed $\cong 270$ rpm) and then decreases with further increase in rotational Reynolds number.

The above mentioned trend may be due to the effect of centrifugal force created due to the rotation of the inner surface of the annular tube and consequently the rotation of fluid layer in contact with the rotated surface. Increasing the rotational speed to a certain value increases the centrifugal force and consequently mixing of fluid and boundary layer disturbance occurs, This in turn increasing the heat transfer rate At higher values of rotational speed fluid layer adjacent to the rotating inner tube may be slipped over it. This means less rotation of water inside the annular space and consequently minimum centrifugal force prevails from one hand and heat is generated due the friction between the rotating tube and the adjacent fluid from the other hand. This leads to decrease the heat transfer rate with further increase in rotational speed.

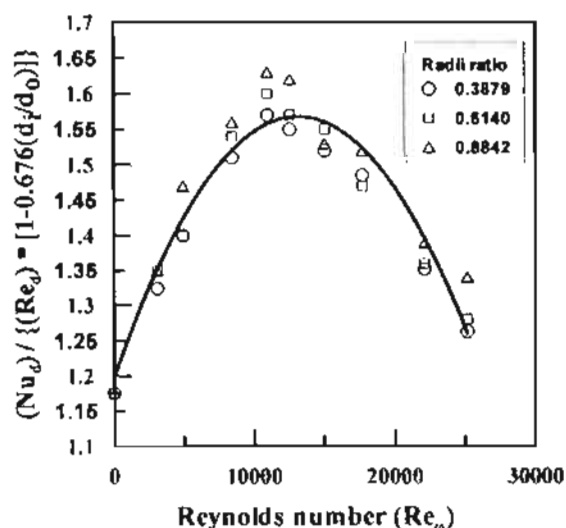

Fig. (8) Effect of rotational Reynolds number on Nusselt number for different radii ratios.

6. Correlation

An attempt was made to correlate the experimental results obtained in the present study. Such correlation is quit useful for the designers to calculate the heat transfer coefficient for similar cases. The average

Nusselt number Nu_h was correlated with the other relevant governing parameters such as axial Reynolds number Re_h , rotational Reynolds number Re_w and radius ratio d_i/d_o of the rotational annular tubes including the results of stationary annular tubes. With the aid of the least square method three steps were made to eliminate Re_h , d_i/d_o and Re_w using computer program (GRAPHER), the following correlation was obtained:

$$Nu_d = 1.199 Re_h^{0.4} f_1(Re_w) f_2(d_i/d_o) \quad (14)$$

Where:

$$f_2(d_i/d_o) = 1 + 0.676(d_i/d_o) \quad (15)$$

$$f_1(Re_w) = 1 + 4.69 \times 10^{-5} Re_w - 1.786 \times 10^{-9} Re_w^2 \quad (16)$$

This correlation is valid for the following ranges parameters:

$$80 \leq Re_h \leq 2700, \quad 2000 \leq Re_w \leq 29400 \text{ and } 0.3879 \leq d_i/d_o \leq 0.8842$$

The above correlation predicts the Nusselt number values within an error of $\pm 18\%$. The above correlation is presented together with the experimental results in Fig (9).

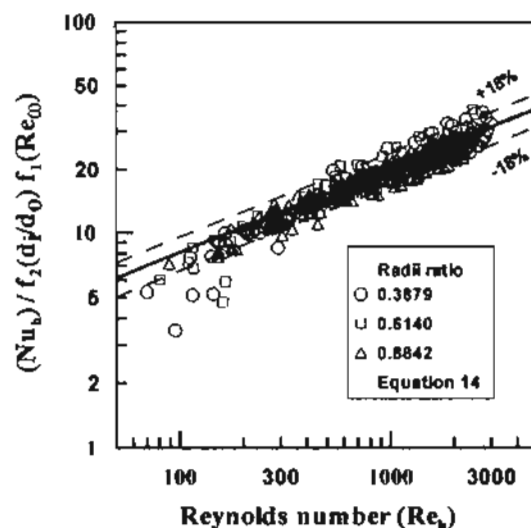

Fig. (9) Effect of rotational Reynolds number on Nusselt number for different radii ratios.

7. Conclusion

Experiments were conducted to evaluate the laminar flow forced convection heat transfer characteristics of water flowing through the annular space of horizontal rotational annular tubes with different values of radii ratios under uniform temperature. The following conclusions can be drawn from the results of this investigations:

1. Nusselt number increases with both axial Reynolds number and the decrease of radius ratio for both stationary and rotational annular tubes.
2. Nusselt number of rotational annular tube is higher than that of stationary annular tubes at the same axial Reynolds number and radius ratio.
3. Nusselt number of rotational annular tubes increases with rotational Reynolds number (rotational speeds) and then decreases with further increase in rotational Reynolds number.
4. Compared to the stationary annular tube results, an increase as high as 44% in heat transfer has been achieved in rotational annular tube having diameter ratio of 0.8842 and rotational speed of 270 r.p.m.

References

1. **Barrow, H.**, "Fluid Flow and Heat Transfer in an Annulus With a Heated Core Tube " Proceedings of the Institution of Mechanical Engineers, Vol. 169, 1955, pp. 1113-1123.
2. **Quarmby, A., and Anand, R., K.**, "Turbulent Heat Transfer in the Thermal Entrance Region of Concentric Annuli with Uniform Wall Heat Flux." International Journal of Heat and Mass Transfer, Vol. 13, 1970, pp. 395-411.
3. **Larkine, B. S.**, "Experimental Measurement of the Effect of Heat Flux on Local Heat Transfer Coefficient and Friction Coefficient in an Annulus" Journal in Mechanical Engineering Science. Vol.7, No. 3, 1965, pp. 300-305.
4. **Kays, W. M., and Leung, E., Y.**, "Heat Transfer in Annular Passages Hydrodynamically Developed Turbulent Flow with Arbitrarily Prescribed Heat Flux" International Journal of Heat and Mass Transfer, Vol. 6, 1963, pp. 537-557.
5. **Kaye, J., and Elgar, E.G.**, "Modes of Adiabatic and Diabatic Fluid Flow in an Annulus With an Inner Rotating Cylinder," Journal of Heat Transfer Trans. ASME, Vol.80. No.3,1958, p.753.
6. **Bjorklund, J. S., and Kays, W. M.**, "The Heat Transfer Between Concentric Rotating Cylinders," Journal of Heat Transfer Trans. ASME, Series C, Vol.81, 1959, pp.175-186.
7. **Becker, K. M., and Kaye, J.**, "The Influence of a Radial Temperature Gradient on the Instability of Flow in an Annulus with a Rotating Inner Cylinder." Trans. ASME, May 1962, pp.106-110.
8. **Becker, K. M., and Kaye, J.**, "Measurement of Diabatic Flow in an Annulus with an Inner Rotating Cylinder," Journal of Heat Transfer Trans. ASME, Series C, Vol.84, May 1962. pp. 97-105.
9. **Luke, G.E.**, "The Cooling of Electric Machines." Trans. ASME, Vol. 42, 1923, p. 646.
10. **Gazley, C.**, "Heat Transfer Characteristics of the Rotational Axial Flow between Concentric Cylinders," Trans. ASME, Vol.80, No.1, 1958.
11. **Tachibana, F., and Fukui, S.**, "Convective Heat Transfer of the Rotational and Axial Flow Between Two Concentric Cylinders," Bull. of JSME, Vol. 7, No.26, 1964.

12. **Molozhen, L. M., and Polyak, M. P.,** "Heat Transfer in an Annulus Between Stationary and Rotating Coaxial Cylinders," *Teploenergetika*, Vol.6, 1970, pp.46-50.
13. **Joo, S. Y.,** "Mixed convection of air between two horizontal concentric cylinders with a cooled rotating outer cylinder" *Int. J. Heat and Mass Transfer*, Vol. 41, No. 2, 1998. pp. 293-302
14. **Lee, T. S.,** "Laminar Fluid Convection between Concentric and Eccentric Heated Horizontal Rotating Cylinder" *Int. J. Numerical Methods in Fluids*, Vol. 14, 1992. pp. 1037-1062
15. **W.M. Kays, M.E. Crawford,** *Convective Heat and Mass Transfer*, third ed., McGraw-Hill, Singapore, 1993.
16. **F.P. Incropera, D.P. DeWitt,** *Fundamentals of Heat and Mass Transfer*, fourth ed., Wiley, New York, 1996.
17. **D. Brian Spalding and J. Taborek,** "Heat Exchanger Design Hand Book", Vol. 1, Heat Exchanger Theory, Hemisphere Publishing Corporation, 1983 (Russian Edition, Energoatomuzdat, page 236, 1987)