

EFFECT OF VERTICAL END-MILLING OPERATIONS UPON
SOME MECHANICAL PROPERTIES OF FREE
MACHINING BRASS PLATES

تأثير عمليات التفريز الرأسية الطرفية على بعض
الخواص الميكانيكية للالواح النحاسية الأخرى

M.Es. Abdel-Moneim*, M.A.N. Shabara **,

A.A.El-Domiaty +, M.A.Shaker ++,

and A.Es. Nassf +++

خلاصة : في هذه الدراسة جرى التفريز الرأسية الطرفية للالواح النحاسية الأخرى سهل القطع -
المتاح - ذات الأبعاد $10 \times 18 \times 10$ مم من جهة واحدة أحيانا أو من الجهتين أحيانا أخرى .
وقد تم تغيير ظروف التفريز على النحو التالي :
- عمق القطع : من 0.1 إلى 1.2 مم .
- سرعة التغذية : من 0.4 إلى 1.58 مم / ثانية .
- سرعة الدوران : من 267 إلى 1330 لفة / ثانية .
أما عينات الشد المستوية فلقد صنعت من نفس الالواح السابق تفريزها بسك 10 مم وطول قياس
فعال 50 مم .
وقد وجد من الدراسة أنه بالنسبة لحالات التفريز من جهة واحدة فإن الزيادة في عمق القطع
من 0.1 إلى 1.2 مم أدت إلى زيادات في قيم أقصى مقاومة حقيقية للشد من 600 إلى 650 ميغاباسكال ،
ومن جهة أخرى فإن القيم المناظرة في حالة التفريز من جهتين كانت من 620 إلى 670 ميغاباسكال .
وقد تراوحت انفعالات الكسر المناظرة ما بين 0.16 إلى 0.20 . لحالات التفريز من جهة واحدة ومن 0.125 إلى 0.175
لحالات التفريز من الجهتين . وقد لوحظ في كل الحالات زيادات طفيفة في مقاومة
الشد الحقيقية القصوى للمادة مع زيادات ملحوظة في انفعالات الكسر وذلك عند زيادة سرعات
الدوران . ولم يلاحظ أي تغيير في معامل التصليد الانفعالي في كل تجارب الاختبار .
ولقد افترض أن مقاومة الكلال مساوية لـ 0.3 من مقاومة الشد القصوى للمادة في كل الحالات .

1-ABSTRACT

Test specimens made of as-received free machining brass plates having dimensions of $(10 \times 180 \times 100) \times 10^{-3}$ m were vertical end milled from one or from two sides in some cases. Milling conditions varied from $(0.1$ to $1.2) \times 10^{-3}$ m depth of cut, and feed speed ranging between $(0.4$ to $1.58) \times 10^{-3}$ m/s for spindle speeds of $(2.67$ to $13.30)$ rev./s. Flat tensile test specimens were made out of the same milled plates having 10×10^{-3} m thickness and 50×10^{-3} m gauge length.

It was found, for cases of one side milling, that the increase of depth of cut from 0.1×10^{-3} m to 1.2×10^{-3} m led to increases in the values of the maximum true tensile strength from $(600$ to $650)$ MPa. On the other hand, the corresponding values for double sides milling cases, varied from $(620$ to $670)$ MPa. The corresponding fracture strains ranged from 0.16 to 0.20 for cases of milling from one side to 0.125 to 0.175 for double sides milling cases. In all cases, slight decreases in the material true ultimate tensile stresses with noticeable increases in the fracture strains were noted upon the increase in spindle speeds. No change in the material strain-hardening exponents were noted through all the conducted tests. Material fatigue strength was taken to be equal to 0.3 of the true ultimate strength.

2. INTRODUCTION

The effect of the mechanical machining operations, such as turning and milling, on the mechanical properties of materials is an important research topic particularly for aircraft industry. It has been generally observed that the machining conditions affect the nature and magnitude of the residual stresses [1-3] which, in turn, may have an influence on the mechanical properties of the workpieces.

* Prof. of Production Engineering & Machine Design.

+ Lecturer ++ Associate Professor +++ Associate Lecturer.

All of: Department of Production Engineering, Faculty of Engineering and Technology, Suez Canal University, Port-Said, Egypt.

** Associate Prof., Dept. of Industrial Prod., Faculty of Eng., Mansoura University.

The residual stresses are known to cause alterations in the grain size of workpieces [4]. Machining processes may, therefore, result in some variations in the strength and ductility of the worked material.

The purpose of this study is to determine the effect of vertical end-milling operations on the ultimate tensile strength, the endurance limit, and ductility of free-machining brass plates.

3. EXPERIMENTAL PROCEDURE

The effect of vertical end-milling operations upon some mechanical properties of free-machining brass plates was studied via the following test program:

- (a) the ultimate tensile strength, the endurance limit (taken as 0.3 of the ultimate tensile strength [5]), and the ductility (taken as the fracture strain) were experimentally measured at a fixed value of the end-mill speed of 160 Rpm. Depth of cut and feed speed varied from 0.1 to 1.2 mm and from 0.4 to 1.58 mm/s, respectively.
- (b) Similar experiments were conducted at two additional end-mill speeds of 400 and 800 Rpm.

Free machining brass blocks having chemical composition of 62-65% Cu, 34-36% Zn and 2-4% Pb and of dimensions $(100 \times 18 \times 10) \times 10^{-3}$ m were dry end milled under various cutting conditions according to Table (1).

Three similar flat tensile test specimens taken from stressed blocks, for each machining test, were, then, subjected to conventional uniaxial tensile tests (See Fig 1). A 20 ton universal testing machine equipped with a load-elongation unit was utilized. The overall effect of residual milling stress upon workpieces mechanical properties were, then evaluated.

Table (1): The (dry) milling conditions (at a constant longitudinal feed rate (S_m) of 0.75×10^{-3} m/s).

| one Side Machining Tests | | | Two Opposite Sides Machining Tests | | |
|--------------------------|-------------------------|-----------------------------|------------------------------------|-------------------------|-----------------------------|
| Test No. | End mill Speed N,R.P.M. | Depth of out t, 10^{-3} m | Test No. | End mill Speed N,R.P.M. | Depth of Out t, 10^{-3} m |
| A1 | 160 | 0.1 | B1 | 160 | 0.1 |
| A2 | | 0.4 | B2 | | 0.4 |
| A3 | | 0.8 | B3 | | 0.8 |
| A4 | | 1.2 | B4 | | 1.2 |
| A5 | 400 | 0.1 | B5 | 400 | 0.1 |
| A6 | | 0.4 | B6 | | 0.4 |
| A7 | | 0.8 | B7 | | 0.8 |
| A8 | | 1.2 | B8 | | 1.2 |
| A9 | 800 | 0.1 | B9 | 800 | 0.1 |
| A10 | | 0.4 | B10 | | 0.4 |
| A11 | | 0.8 | B11 | | 0.8 |
| A12 | | 1.2 | B12 | | 1.2 |

4. EXPERIMENTAL RESULTS AND DISCUSSION

The results of the study are presented in various ways. Fig. 2, for example, illustrates the engineering stress-strain diagrams for the tested material before and after the end-milling operations. The diagrams have been obtained at different depth of cut for single side milling (group A) and double side milling (group B) at a spindle speed of 160 Rpm and a feed rate of 0.75 mm/s in the dry conditions. Fig. 3 illustrates the same diagrams on a logarithmic scale. Fig. 4 indicates another set of engineering stress-strain diagrams which have been obtained at various spindle speeds and at a depth of cut of 1.2 mm and a feed rate of 0.75 mm/s.

Figures 5-10 illustrate three-dimensional plots and contour plots for the ultimate tensile stress, the endurance limit, and the fracture strain for single side and double side milling groups. Figures 11-13 show super-imposed results for both milling conditions for comparison reasons.

It can be generally observed from these plots that at the same spindle speed, both the ultimate strength and, hence the endurance limit, of the material increase as the depth of cut increases. For the usual practice of single-sided milling (test group A), noticeable increase in the ultimate tensile strength took place reaching, for instance, around 570 MPa for a depth of milling equal 1.2 mm while it was only about 400 MPa before milling. As the depth of cut increases so do the material work hardening characteristics leading to higher strength values. This may be attributed to the increase in the ensued surface and sub-surface residual compressive stresses for higher depth of cut. This behaviour is illustrated separately in Fig. 14. The increase in the ensued surface and sub-surface residual stress for higher depth of cut appears in Fig. 15 [6].

Double-surface milled specimens (test group B) acquired even higher strength values than that of single-surface milled workpieces (test group A). Corresponding increases in specimens yield strengths are revealed at higher depths of cut.

On the other hand, the fracture strain, and hence the material's ductility, is seen to decrease as the depth of cut increases. The fracture strain in the double-sided milling is lower than that for single-sided milling for the same milling conditions. This behaviour is presented in Fig. 16.

The stress-strain relation for the material may take the power law form;

$$\sigma = K \epsilon^n$$

The strength coefficient (K) and the strain-hardening exponent (n) may be determined via the logarithmic plots $\ln \sigma - \ln \epsilon$ shown in Figures 3 & 4. In all cases, the strain-hardening exponent (n) is found to have a constant value irrespective of the change in depth of cut. This may be understandable, since the same type of variation is bound to produce the same type of effect. However, the strength coefficient (K) is found to be higher for higher depth of cut revealing real strength increases.

Similar conclusions may be drawn for the case of constant depth of cut and different spindle speeds. That is, both the ultimate tensile stress and the endurance limit for the test material are seen to increase as the spindle speed increases, for the same depth of cut. An inverse behaviour can be seen for the fracture strain. This behaviour is being illustrated in Figures 17 & 18, respectively.

The strengthening mechanism which is at work here is thought to be based on the nature of the residual elastic strain that may be due, mainly, to inequity in interatomic distances [7].

The effective internal energy of the material is needed to initiate slip at given higher stress levels.

In addition to this possible strengthening mechanism, there may exist other mechanisms. In situations where slip is enhanced, its movements may take place at higher stress levels leading to higher strength [7]. The third principle is the one which explains the increase of internal mechanical energy, via sub-recrystallization plastic deformation or via grain boundary growth or due to alloying elements [8].

5- CONCLUSIONS

From the experimental study on the effect of vertical end milling on the mechanical properties of free-machining brass, the following conclusions may be drawn:

- 1- The tensile strength and endurance limit increase for cases of higher depths of cut and slower cutting speeds for one side as well as two sides milling.
- 2- The two sides milling strengthens brass more than the conventional one side milling.
- 3- The fracture strain decreases as the depth of cut increases and the cutting speed decreases for the two milling processes.
- 4- The fracture strain decreases at a greater rate for one side milling than for two sides milling.
- 5- Vertical end-milling yields compressive residual stresses which are advantageous to the milled pieces, especially if milling is conducted from two parallel sides, as far as the tensile strength and endurance limit are concerned.
- 6- Vertical end-milling operations lead to lower workpiece ductility, especially after two sides machining.

6- REFERENCES

- 1- Field, M., and Kahles, J.F., Report 210, 1964, P.54
- 2- Barash, M.M., and Schoech, W.J., "A Semi-analytical Model of the Residual Stress Zone in Orthogonal Machining", Proc. of the 11th. Int. M.T.D.R. Conf., Birmingham, G.Britain, Sept. 1970, PP. 603-613.
- 3- Liu, C.R., and Barash, M.M., "Variables Governing Patterns of Mechanical Residual Stress in a Machined Surface", Trans. ASME, Series B, J. Engg. Industry, Nov.22, 1982, PP 1-8.
- 4- Dieter, G.E., "Mechanical Metallurgy", Second Edition, Mc Graw-Hill, June 1961.
- 5- Khurmi R.S. and Gupta J.K., "A Text Book of Machine Design", Eurasia publishing House (Pvt) Ltd. New Delhi, India, 1983.
- 6- Nassf.A.Es, "Residual Stresses Due to Vertical Milling Operations", M.Sc. Dissertation, Suez Canal University, Port-Said, Egypt, March 1989.

- 7- Datsko, J, "Material Properties and Manufacturing Process," John Wiley & Sons, Inc. New York, 1967.
- 8- Abdel Moneim, M. Es, El-Kabeery, M. M, and Es.nassf, A. Es, "Assessments of Residual Stresses In Some Metal_machining Processes-Case Studies", Proc. of 4th Cairo University Conf. on Mechanical design and Production, Cairo Egypt, December 27-29, 1988.

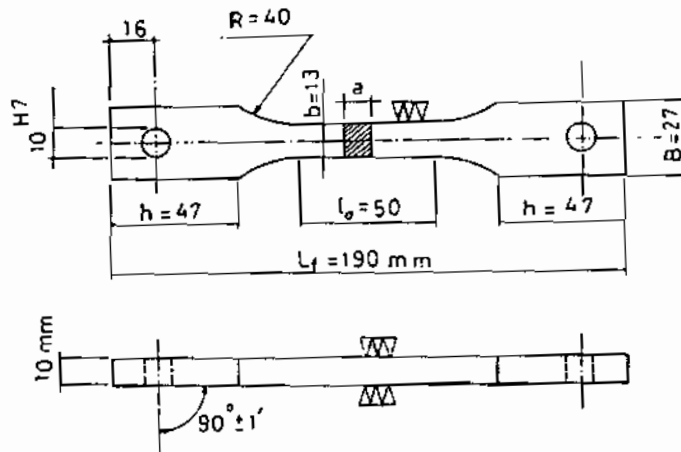

Figure 1. Dimension of Specimen According to (DIN 50114)

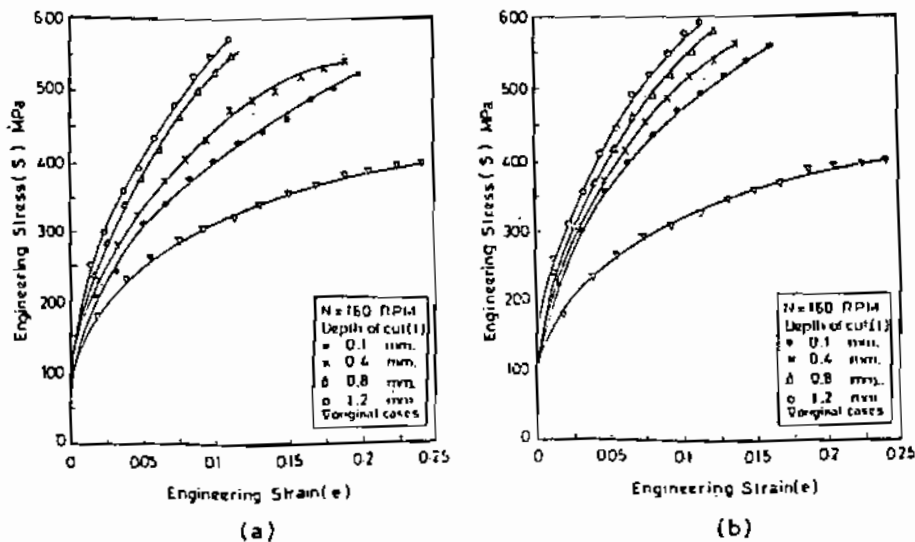

Figure 2. Engineering stress (S_e) versus Engineering strain (e_e) for different Depths of cut (t) at a spindle speed (N) of 160 R.P.M. and a feed rate (S_m) of 0.75×10^{-3} m/s.
 a) Single surface milling tests, (b) Two opposite surface milling tests.

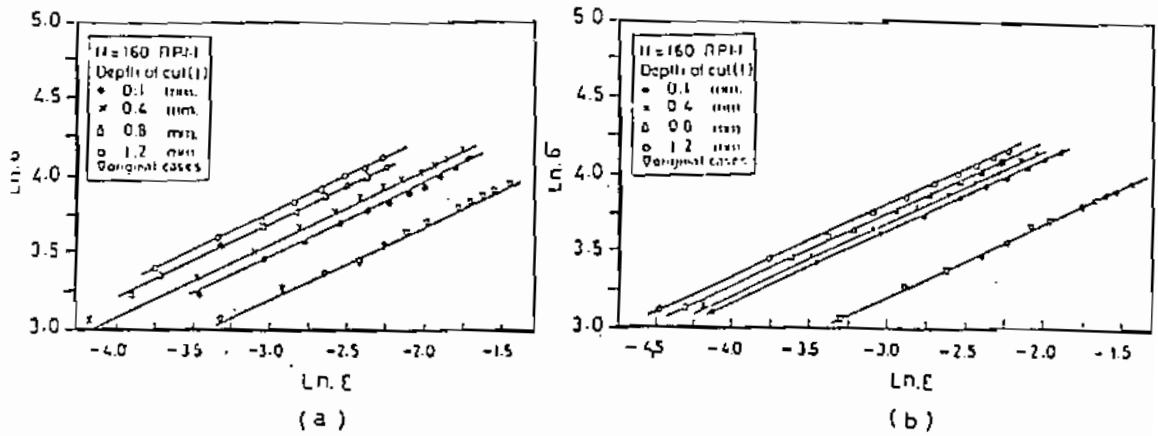

Figure 3. Logarithmic stress-strain plots for different depths of cut at a feed rate (S_m) of 0.75×10^{-3} m/s. a) Single surface milling tests, (b) Two opposite surfaces milling tests.

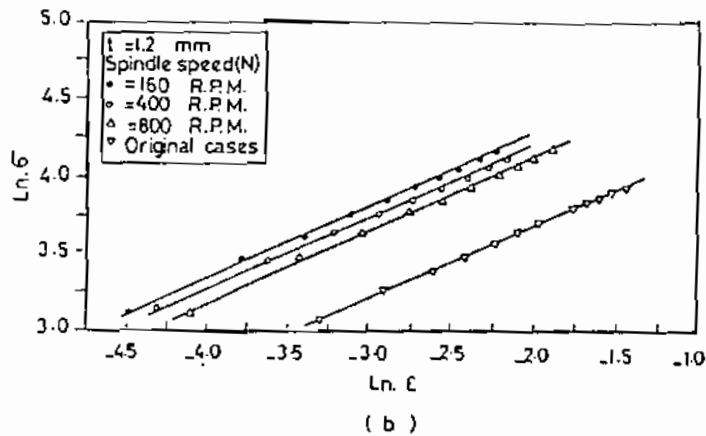
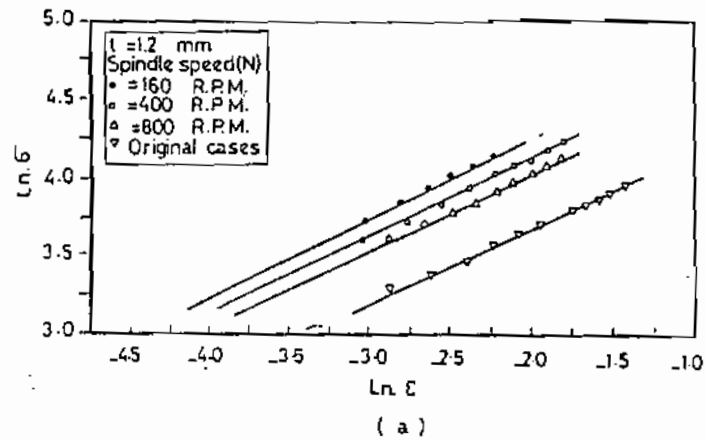

Figure 4. Logarithmic stress-strain plots for different depths of cut at a feed rate (S_m) of 0.75×10^{-3} m/s. a) Single surface milling tests, (b) Two opposite surfaces milling tests.

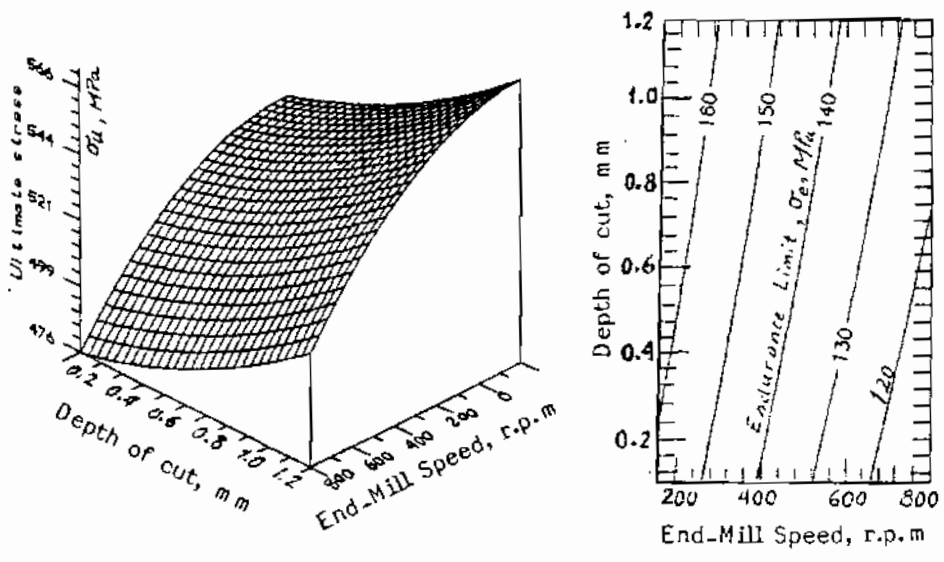

Fig. 5. Three-Dimensional and Contour Plots of the Ultimate Stress versus Spindle Speed and Depth of Cut (Single-side Milling)

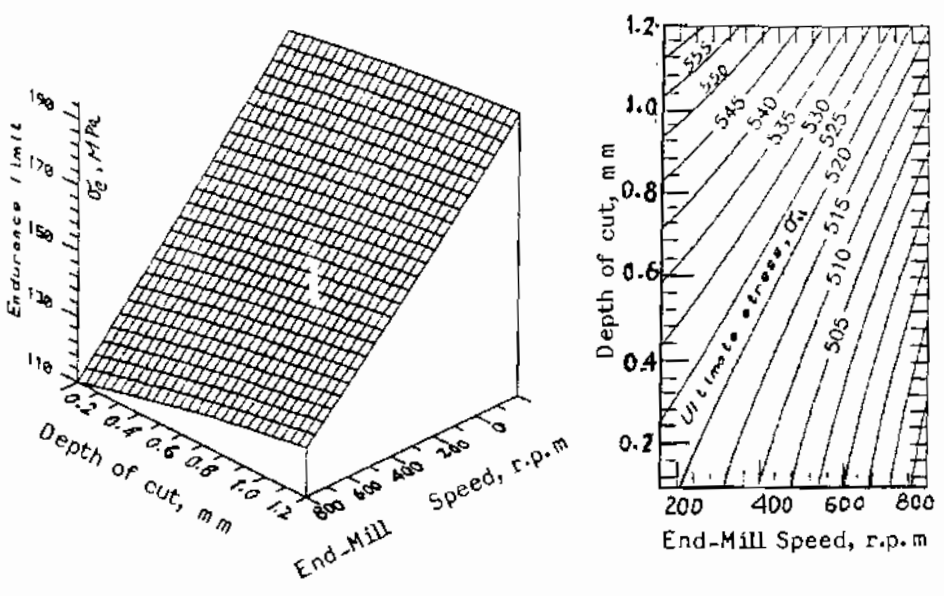

Fig. 6. Three-Dimensional and Contour Plots of the Endurance Limit versus Spindle Speed and Depth of Cut (Single-Side Milling)

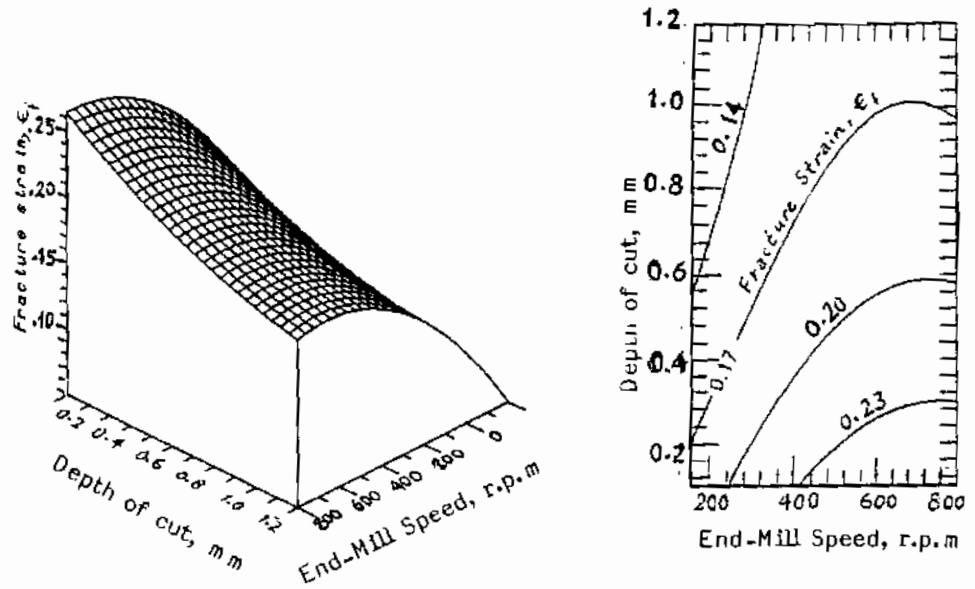

Fig. 7. Three-Dimensional and Contour Plots of the Fracture Strain versus Spindle Speed and Depth of Cut (Single-Side Milling)

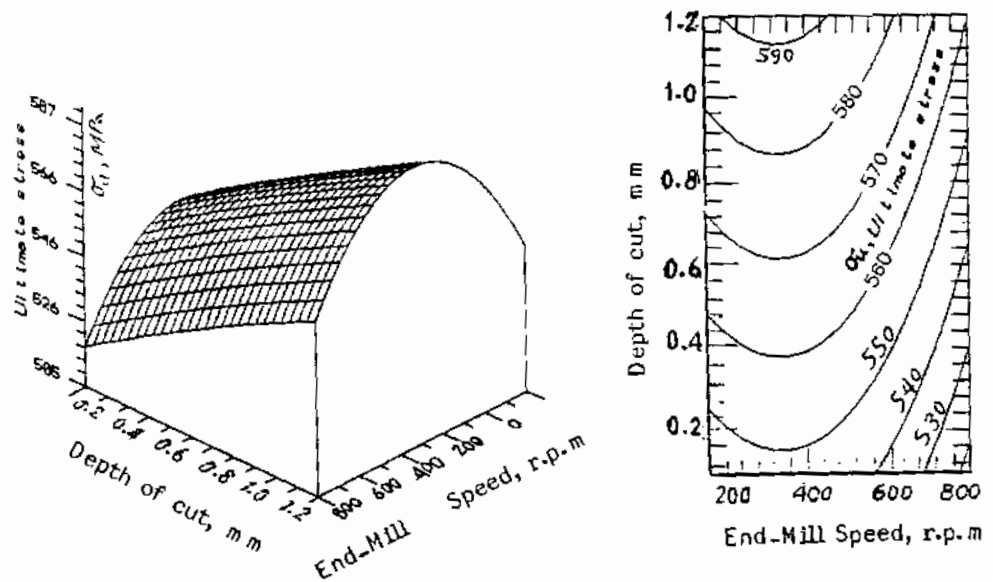

Fig. 8. Three-Dimensional and Contour Plots of the Ultimate Stress versus Spindle Speed and Depth of Cut (Double-Side Milling)

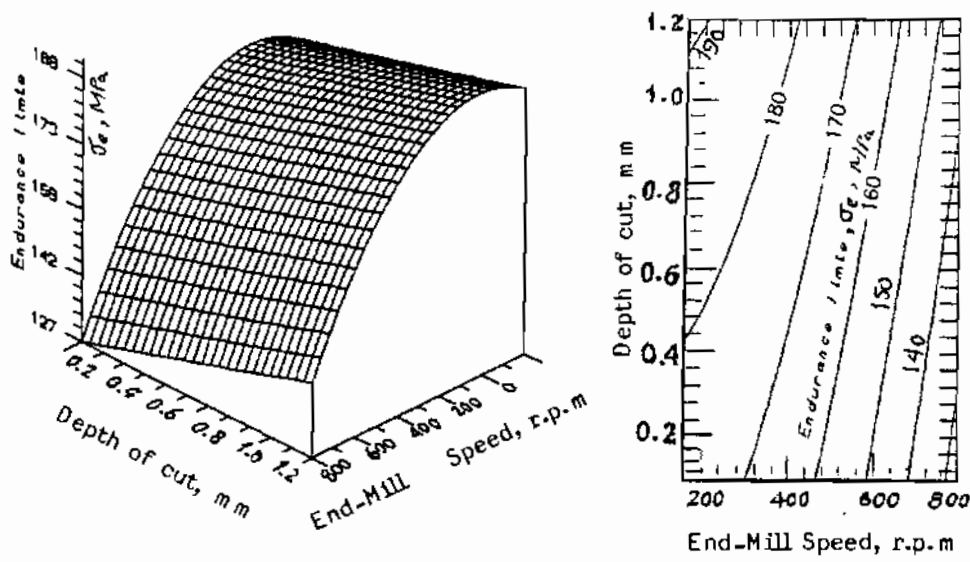

Fig. 9. Three-Dimensional and Contour Plots of the Endurance Limit versus Spindle Speed and Depth of Cut (Double-Side Milling)

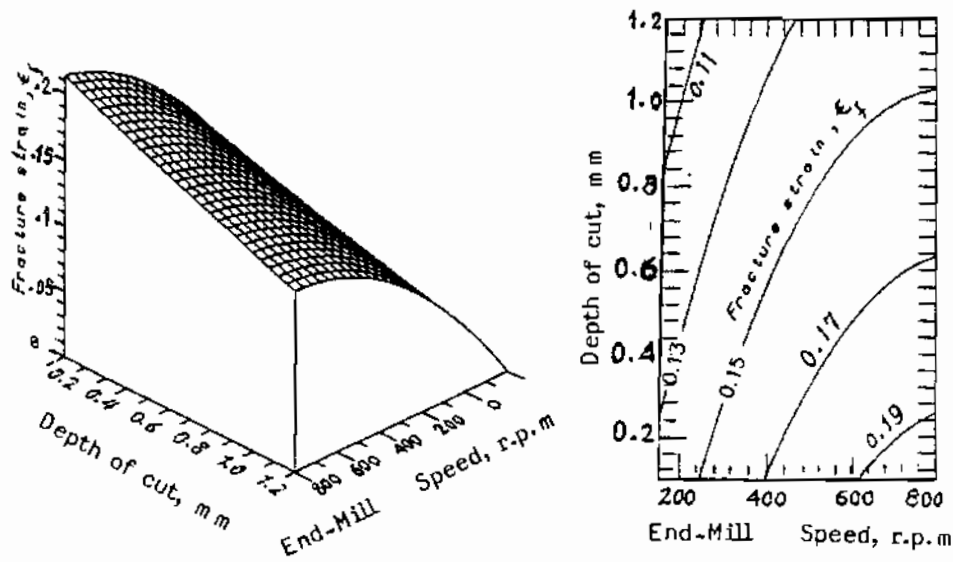

Fig. 10. Three-Dimensional and Contour Plots of the Fracture Strain versus Spindle Speed and Depth of Cut (Double-Side Milling)

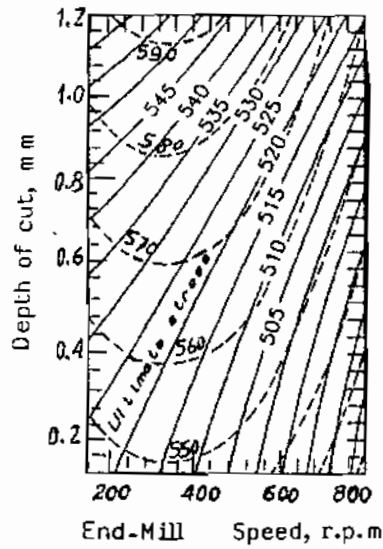

Fig. 11 Contour Plots of the Ultimate Stress versus Spindle Speed and Depth of Cut

Continuous Lines: Single-side Milling
Dashed Lines: Double-side Milling

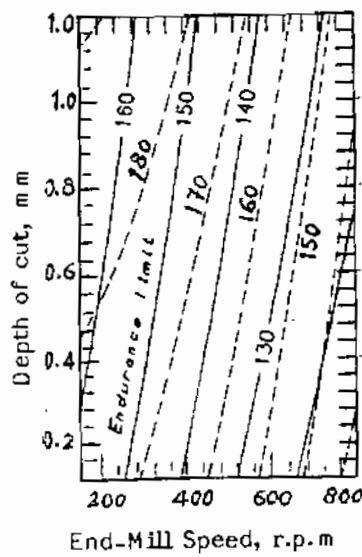

Fig. 12. Contour Plots of the Endurance Limit versus Spindle Speed and Depth of Cut

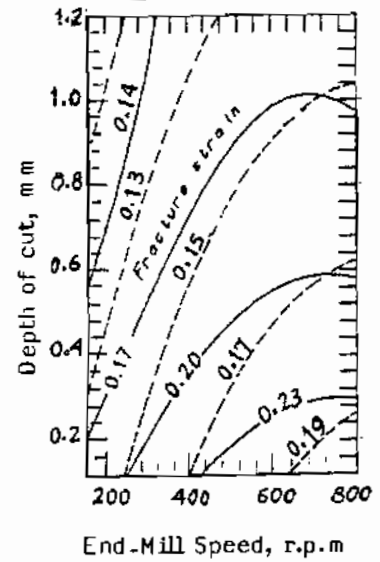

Fig. 13. Contour Plots of the Fracture Strain versus Spindle Speed and Depth of Cut

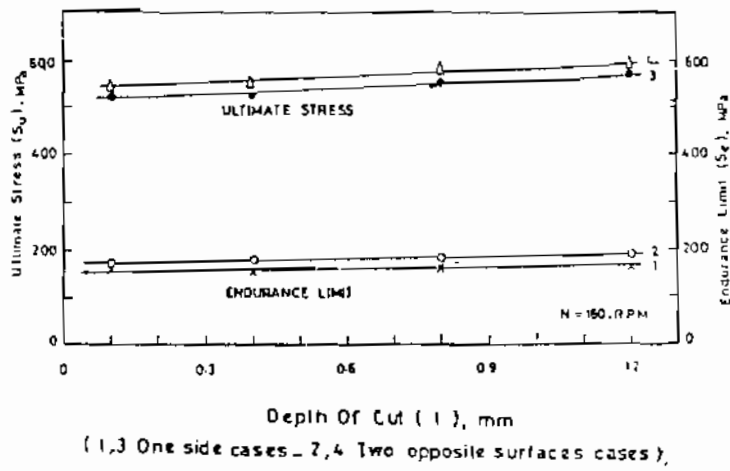

Figure 14. Ultimate tensile strength (S_u) and Endurance limit (S_e) versus depth of cut at a feed rate (S_m) of 0.75×10^{-3} m/s.

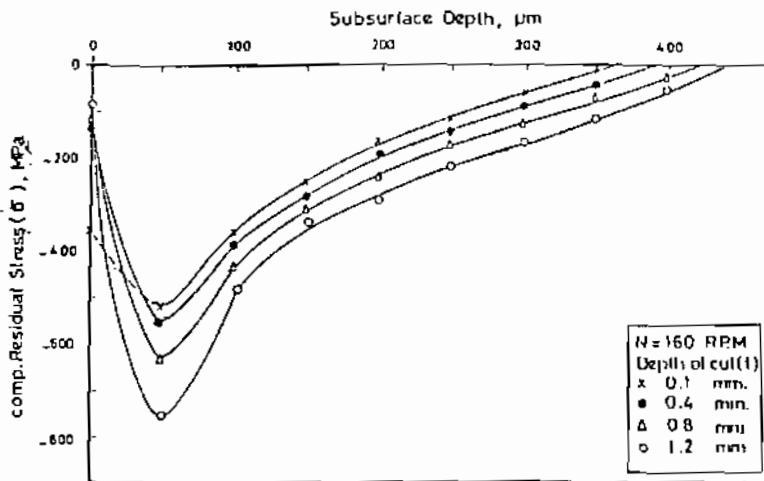

Figure 15. A typical example for the relationship between the compressive residual stress and the sub-surface depth at different depths of cut (t) for a feed rate (S_m) of 0.75×10^{-3} m/s.

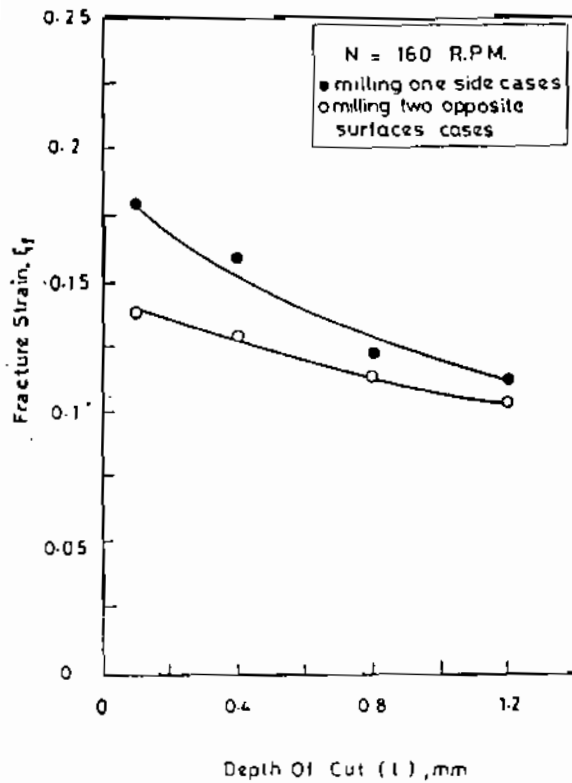
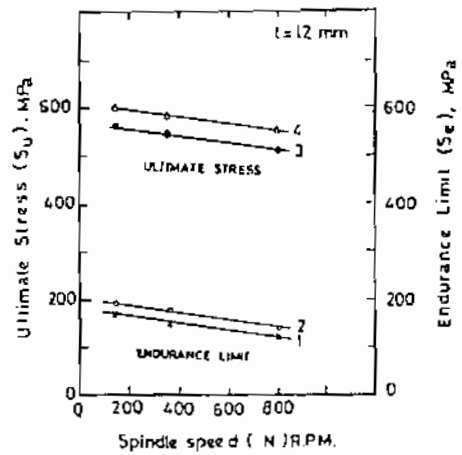

Figure 16 Fracture strain (ϵ_f) versus depth of cut (t) at a feed rate (S_m) of 0.75×10^{-3} m/s.



(1,2) One side cases, 2,4 Two opposite surfaces cases

Figure 17 Ultimate tensile strength (S_u) and Endurance limit (S_e) versus spindle speeds (N) at a feed rate (S_m) of 0.75×10^{-3} m/s

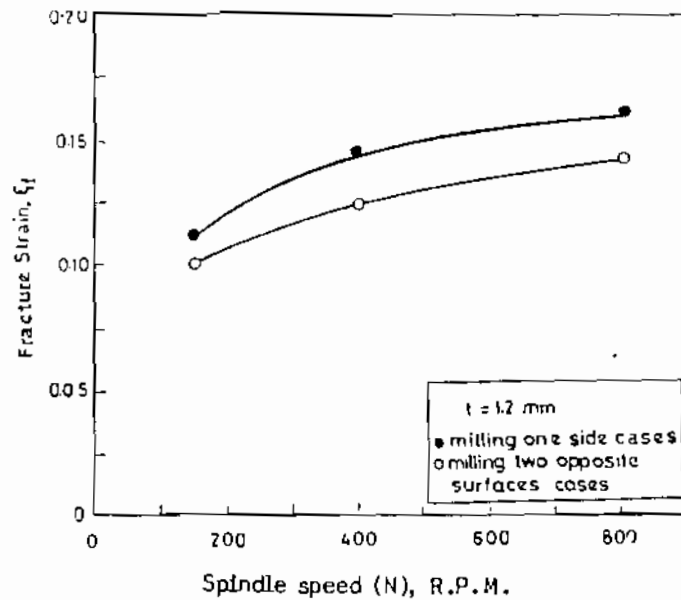

Figure 18. effect of speed change upon the fracture strain at a depth of cut 1.2×10^{-3} m for both test groups (A) and (B)