

PANELED COMPOSITE BEAMS

الكمرات المركبة المتقاطعة

A. Almohamady¹

Lecturer, Faculty of Engineering, Misr University for Science and Technology (MUST), Cairo, Egypt.

خلاصة

تم استخدام القطاعات المركبة حديثاً وذلك للمميزات العديدة بها وأهمها إمكانية الحصول على قطاعات أصغر حجماً بكفاءة أعلى من حيث مقاومة إجهادات الشد والضغط. وقد تمت دراسة الكمرات المركبة في بعض الأكواد إلا أنها لم تتم دراستها بالصورة الكافية حيث أن السلوك الإنشائي لها من الصعب التوقع به كما أنها تحتاج إلى الكثير من الدراسة النظرية والعملية. كما أن التصميم الإنشائي للكمرات المركبة المتعامدة يتعامل معها على أساس كمرات ثانوية بسيطة الارتكاز أو مستمرة على كمرات رئيسية وهو ما يخالف التصرف الفعلي لها حيث تعمل ككمرات متقاطعة لها نفس الترخيم عند نقاط التقاطع وذلك يؤدي بالطبع إلى نتائج غير حقيقية غير آمنة في بعض الأحيان. وتقوم هذه الدراسة بمحاولة تمثيل هذا النظام الإنشائي باستخدام نظرية العناصر المحددة مع تفسير النتائج ووضع النتائج والتوصيات اللازمة وأخذها في الاعتبار أثناء التصميم الإنشائي.

ABSTRACT

Recently, composite members had been widely used in construction, where the use of appropriate materials arranged in an optimum geometric configuration providing the required compressive and tensile strength, achieve greater stiffness, material saving, less own weight and better vibration resistance.

Unfortunately, the behavior of continuous composite beams supported on other beams is unpredictable and such system requires a more complicated design.

Most of the current design codes do not mention the behavior of this system due to the lack of both experimental data and practical experience. Therefore the designer usually ignores the real behavior of such system which acts as a paneled beam system, and considers the secondary beams as simply supported composite beams, or as continuous steel beams leading to either unsafe results or over conservative results, due to the lack of adequate code guidance.

Thus, this paper explains the behavior of such system using linear finite element analysis, together with the most important factors affecting it.

Keywords : Pre-stressed, Stiffeners, Finite Element Analysis (FEA), Composite beams, Steel beams

Introduction

In earlier days, the design of long spans less than 10 meters are usually constructed of reinforced concrete since no other material has a better combination of low cost, high strength and resistance to corrosion, and fire [1].

In case of spans more than 10m, and fire damage not an issue, steel beams become cheaper than concrete beams. Since 1950 the development of shear connectors had made it practical to connect the slab to the beam obtaining T-beam action known as composite beam.

The advantages of composite beams are:

- Higher Span/depth ratios
- Higher fundamental frequency of vibration
- Higher fire resistance
- Less own weight and more economy.

Problem statement and objective

Egyptian code of practice for steel construction and bridges (code No 205 – 2001) [2] did not give any definition for composite continuous beams, but it mentions only that there are three methods of design of sections subjected to negative moment regions at the support. This means that the definition of continuous composite beams is that which is subjected to negative moment at the supports.

The definition of continuous composite beams given in EURO code 4 part 1.1[3] is :A beam with three or more supports, in which the steel section is either continuous over internal supports or is joined by rigid connections at each support such that it can be assumed that the supports do not transfer significant bending moment to the beam. At the internal supports, the beam may have either effective reinforcement or only nominal reinforcement. Therefore, in our case of study as will be shown later, the secondary beams cannot be considered as continuous composite beams, where the whole beam is subjected to positive moment. Besides, the steel section of the secondary beams is neither continuous over internal supports nor jointed by full-strength rigid connections. In such case, there is lack of adequate code guidance which leads the designer usually to ignore the real behavior of a paneled beam system. Thus, this paper explains the behavior of composite paneled beam system

using linear finite element analysis, together with the most important factors affecting it.

Tested model using F.E. analysis

The tested model consists of a 6 meters span main girder supporting 4 beams as secondary beams, each having a 4 meters span. The connection between the main girder and each of the secondary beams is a pinned connection to transfer shear only, see Figure (1).

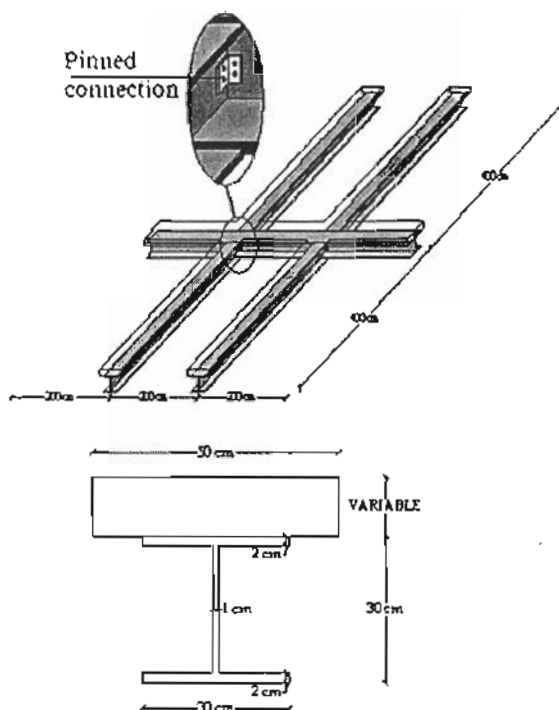

Types of cross section for main girder and secondary beams

Figure (1), Tested model

Each of the secondary beams is subjected to a distributed load of 0.75 t/m^2 .

The model will be tested in each of the following 3 cases:

- System I :Assuming that the secondary beams are simple composite beams, producing a reaction on the main girder equal to (wxl) . The following analyses will be conducted:
 - The secondary beams will be analyzed alone.
 - The reversed reactions of the secondary beams on the main girder will be analyzed as shown in Figure (2).
- System II :Assuming that the secondary beams are resisting the applied load

together with the main beam as a paneled beam system figure (3). The whole model will be tested with different slab thicknesses under the condition that the tension stresses affecting the concrete are within the range allowed by the code clause 10.1.4.5-Table 10.2 which implies that the concrete would not be affected by any cracks. The purpose for the variation in slab thickness is to show its effect on the whole composite paneled beam system.

- System III : Assuming that the secondary beams are simple composite beams and that such beams are pinned connected to the main girder as shown in figure (4), and the effective part of concrete connecting the secondary beam to the main girder is completely cracked. The main girder will suffer a deformation equivalent to its stiffness and such deformation will in turn affect the secondary composite beams .

Finite element model

The finite element method, sometimes referred to as finite element analysis, is a computational technique used to obtain approximate solutions of boundary value problems in engineering [4].

A linear analysis technique using SAP 2000 version 10 [5] was used to analyze the tested model.

The analysis has been carried out on reinforced concrete having tension stresses affecting its bottom fibers within the range allowed by the code clause 10.1.4.5-Table 10.2 .This implies that the bottom fibers would not be affected by any cracks. In case the tension stresses affecting the concrete bottom fibers exceed the range allowed by the above-mentioned code clause, a non-linear analysis has to be conducted which can be covered in further studies .

The steel beams were simulated in the model using 8-noded solid element, having Young's modulus of elasticity $E = 2100 \frac{\text{t}}{\text{cm}^2}$ and Poisson's ratio $\nu = 0.3$, while the reinforced concrete slab was simulated in the model using 8-noded solid element with $E = 14000 \sqrt{f_{cu}} \frac{\text{kg}}{\text{cm}^2}$ [6], and $\nu = 0.2$ Figure (2).

The restraints of the supports of Case 1 having end conditions as given in table (1):

Table (1), see Figure (2)

Support index	X-Global Direction	Y-Global Direction	Z-Global Direction
Restrained Condition			
I-1	YES	NO	YES
I-2	YES	YES	YES
I-3	YES	YES	YES
I-4	YES	NO	YES

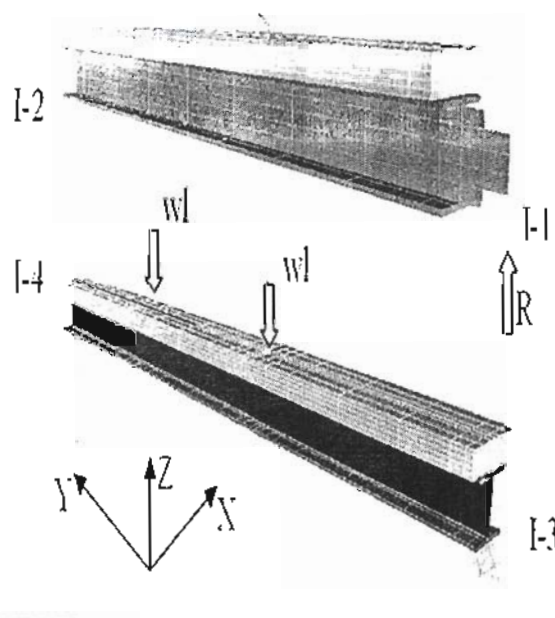

Figure (2), Finite element model case 1

The restraints of the supports of Case 2 having end conditions as given in table (2):

Table (2), see Figure (3)

Support index	X-Global Direction	Y-Global Direction	Z-Global Direction
Restrained Condition			
II-1	NO	YES	YES
II-2	YES	NO	YES
II-3	NO	NO	YES
II-4	YES	NO	YES
II-5	NO	NO	YES
II-6	NO	NO	YES

Meanwhile the end conditions of the supports of Case 3 have the same restrained conditions as Case 2.

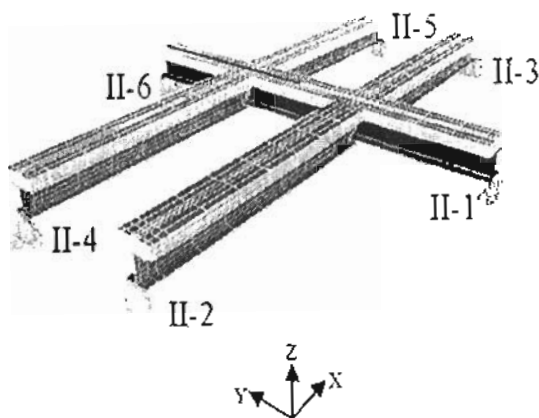

Figure (3). Finite element model System II

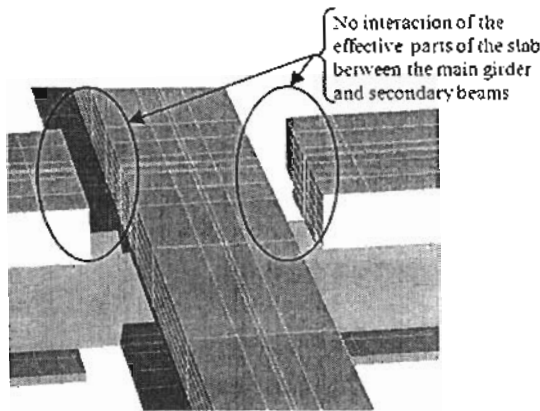

Figure (4). Finite element model System III

The pinned connections were simulated in the model by constraining the translation degrees of freedom for each pair of the secondary beams nodes on either side of the main girder nodes within the secondary beams webs and the main girder web respectively as shown in Figure (5).

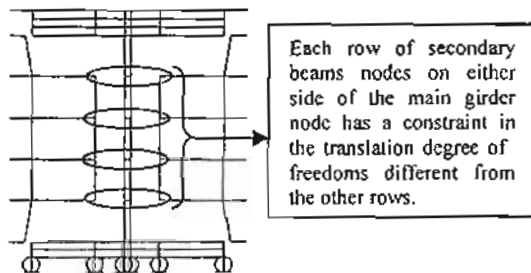

Figure (5). Pinned connection

Since all design of composite beams in practice is based on the assumption that full interaction is achieved, where the effective part of the concrete and the steel beam are joined together by an infinitely stiff shear connectors, therefore,

the shear connectors were simulated in the model by 2 nodes frame elements. Where full interaction was taken into consideration in both global directions X and Y by making the 2 nodes have equal constraints for all translation degrees of freedom.

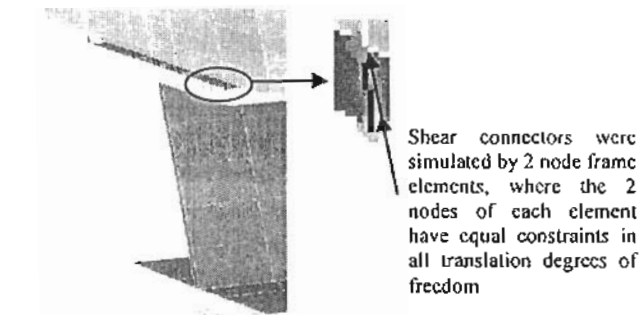

Figure (6). Shear connectors

Results from analysis

The deflections of Systems I, II and III of the secondary beams are shown in Fig. [7].

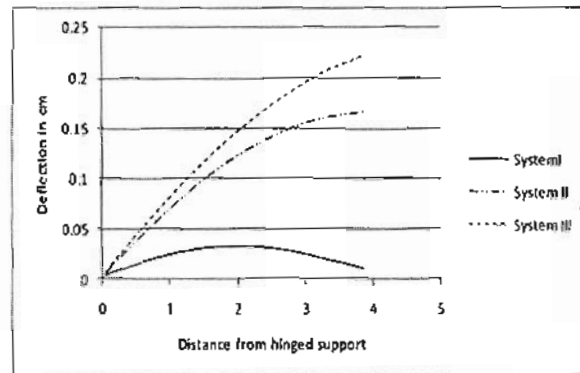

Figure (7). Deflection of secondary beams along their span.

The deflection of System I decreased by approximately 76 % than that of System II. This is due to taking into account the deformation suffered by the main girder in System II which is equivalent to its stiffness and in turn affects the secondary composite beams. However in System I such deformation suffered by the main girder was not taken into account and hence System I can lead to unsafe design of the secondary beams.

The deflection of System III increased by approximately 34 % than that of System II. This is due to not taking into account the resistance of the effective part of concrete slab between the main girder and the secondary beams which leads to higher deflections. The deflection of

System I, System II and System III of the Main Girder are shown in Fig. (9).

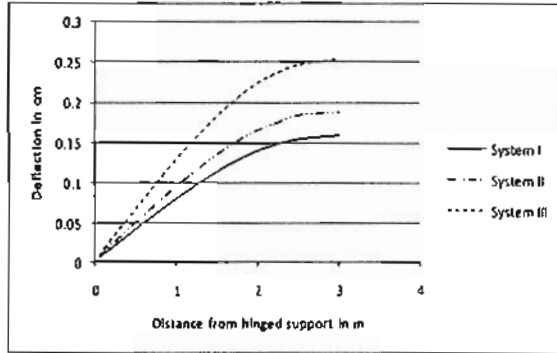

Figure (8), Deflection of main girder along its span.

The deflection in System I decreased by approximately 15 % than that of System II, this is due to that in System I the secondary beams are analyzed as simple composite beams leading to a less deflection for the main girder, despite the fact that the actual case is that the secondary beams are working together with the main girder as a paneled beam system leading to a higher deflection .

The deflection of the main girder in System II is less than that of System III by approximately 25%, which is almost the same increment as in the case of the secondary beams since the lack of resistance of the effective part of concrete slab connecting the secondary beam to the main girder affects both the main girder and the secondary beams with the same ratio . Therefore, by improving the resistance of above-mentioned concrete slab will have approximately an equal positive effect on both the main girder and the secondary beams within the paneled beam system .

Effect of the effective slab thickness on the composite paneled beam system

Three cases were examined for system II, the secondary beams and the main girder of each system has the following cross section dimensions as shown in table (3).

Table (3) Beams dimensions

Case	Slab Thickness (cm)	Flange Width (cm)	Web Depth (cm)	Flange Thickness (cm)	Web Thickness (cm)
1	12	30	26	2	1
2	16				
3	20				

The relationship between the deflection along the beams span and the variation of the slab thickness was examined and illustrated in Figures (9), and (10) .

The variation of slab thickness was described in figures (9), (10) by two factors:

- α : Composite stiffness factor, which indicates the efficiency of the composite action between the reinforced concrete and the steel section.

This factor can be calculated from Elastic stress analysis of a composite beam as follows:

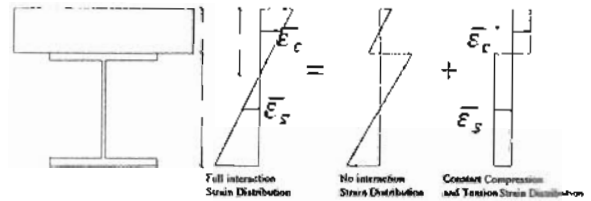

Resultant compressive force in slab:

$$C = \bar{\sigma}_c \times A_c = \bar{\epsilon}_c \times E_c \times A_c = \bar{\epsilon}_c \times R \times \left(t - \frac{t}{2} \right) \times A_c$$

Resultant tensile force in beam:

$$T = \bar{\sigma}_s \times A_s = \bar{\epsilon}_s \times E_s \times A_s = \bar{\epsilon}_s \times R \times \left(t + \frac{h}{2} - t \right) \times A_s$$

From Equilibrium T=C

$$\bar{\epsilon}_c = \frac{t}{t + \frac{h}{2}} \times \left(\frac{\bar{\epsilon}_s \times A_s}{E_s \times A_s + E_c \times A_c} \right)$$

Therefore,

$$T = C = R \times E_c \times A_c \times \left(\frac{t + h}{2} \right) \times \left(\frac{E_s \times A_s}{E_s \times A_s + E_c \times A_c} \right)$$

From Moment Equilibrium:

$$M = M_c + M_s + C \times \left(\frac{h + t}{2} \right) = R \times (E_c \times I_c + E_s \times I_s) + C \times \left(\frac{h + t}{2} \right)$$

$$M = R \times (E_c \times I_c + E_s \times I_s) \times (1 + \alpha)$$

where

$$\alpha = \left(\frac{E_c \times A_c \times E_s \times A_s}{E_c \times A_c + E_s \times A_s} \right) \times \left(\frac{(t + h)^2}{4 \times (E_c \times I_c + E_s \times I_s)} \right)$$

E_c : Young's Modulus of concrete.

E_s : Young's Modulus of steel

A_c : Effective area of reinforced concrete slab.

A_s : Area of steel section

I_s : Second moment of area of steel.

I_c : Second moment of area of concrete.

t : Reinforced concrete slab thickness.

h : Depth of steel section .

- β : Second moment of area factor, which describes the increased amount in the second moment of area due to composite action.

$$\beta = \left(\frac{I_v - I_s}{I_s} \right)$$

I_v : the virtual second moment of area.

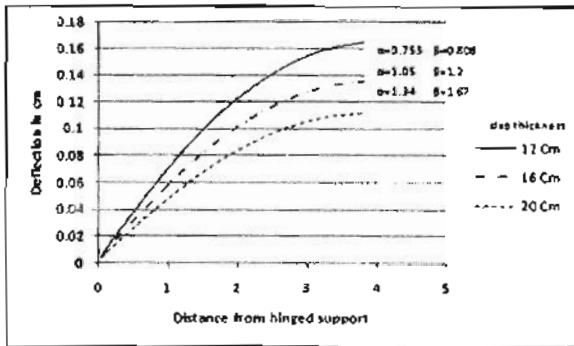

Figure 9), Deflection of secondary beam along its span.

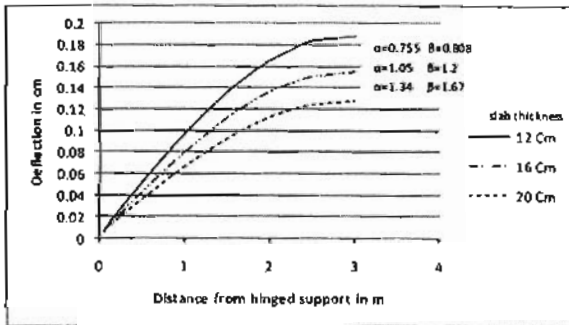
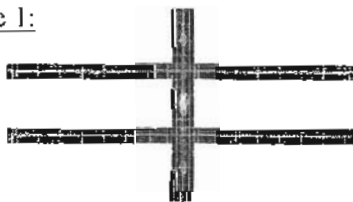

Figure (10), Deflection of main girder along its span.

From figures (9) and (10), it can be noticed that an increase in slab thickness tends to decrease the deflection of the secondary beams as well as that of the main girder.

The stresses in the bottom fibers of the reinforced concrete slab of the given models have been studied under the given value of the distributed load as illustrated in figure (11) for the three cases:

For case 1:



a) Stresses in X-Global direction of concrete fibers located at 12 cm from top.

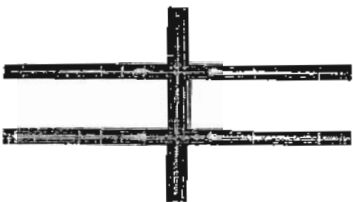

b) Stresses in Y-Global direction of concrete fibers located at 12 cm from top



For case 2:

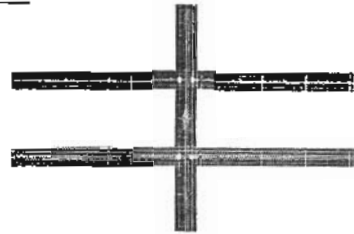

c) Stresses in X-Global direction of concrete fibers located at 16 cm from top.



d) Stresses in X-Global direction of concrete fibers located at 12.8 cm from top.



e) Stresses in Y-Global direction of concrete fibers located at 16 cm from top.

For case 3:

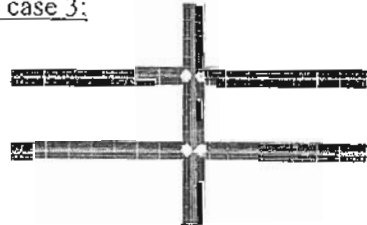

f) Stresses in X-Global direction of concrete fibers located at 20 cm from top.



g) Stresses in X-Global direction of concrete fibers located at 16 cm from top.

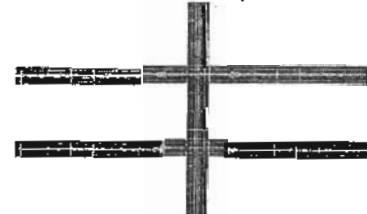

h) Stresses in Y-Global direction of concrete fibers located at 20 cm from top.

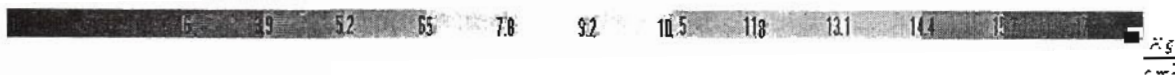

Figure (11), Stresses on Concrete fibers

From figure 11 Case 1 (a), and (b), no tension stresses have occurred in X or Y Global directions on the bottom fibers of concrete at the intersection part between the main girder and the secondary beams.

In case 2, when α increased from 0.755 to 1.05, and β increased from 0.808 to 1.2, the bottom fibers of concrete at the intersection part between the main girder and the secondary beams suffered from tension stresses in the X-Global direction approximately equals to $9 \frac{kg}{cm^2}$, which is less than the allowed value by the code, and the deflection decreased approximately by 21.%

In case 3, when α increased from 0.755 to 1.34, and β increased from 0.808 to 1.67, the bottom fibers of concrete at the intersection part between the main girder and the secondary beams suffered from tension stresses in the X-Global direction approximately equals to $11.8 \frac{kg}{cm^2}$, which is less than the allowed value by the code, and the deflection decreased approximately by 46.%

The appearance of tension stresses at the bottom fibers of concrete at the interaction part between the main girder and the secondary beams in cases 2 and 3 can be explained as the follows in figure (12):

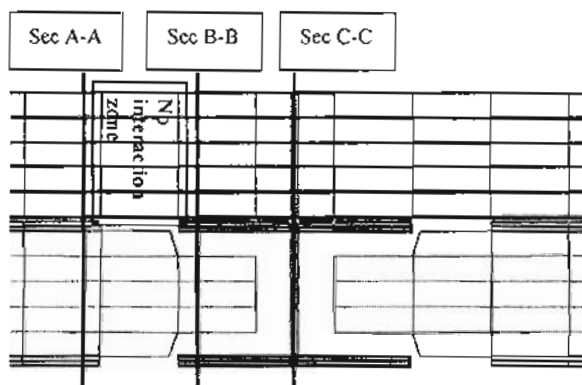
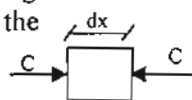

Figure (12), Tension stresses at the bottom fibers of concrete at the interaction part between the main girder and the secondary beams

At section C-C, by taking a segment from the concrete slab located at the bottom fibers with length dx .



Due to symmetric loading and symmetric system, the slippage at this section will be equal to zero, and no shear stresses will occur.

At section B-B, by taking a segment from the concrete slab located at the bottom fibers with length dx , interface shear is produced and by

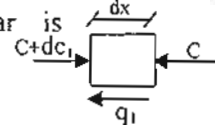

considering the equilibrium of this segment, the shear force can

$$\text{be calculated to be } q_1 = \frac{dc_1}{dx}$$

At section C-C, by taking a segment from the concrete slab located at the bottom fibers, its length is dx , interface shear is produced and by

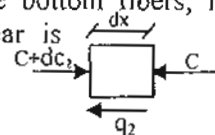

considering the equilibrium of this segment, the shear force can

$$\text{be calculated to be } q_2 = \frac{dc_2}{dx}$$

The difference between q_1 and q_2 produces tensile stresses at the bottom fibers of concrete at the zone where there is on interaction.

Fig. (3) illustrates the composite stiffness factor α and the decreasing percent in deflection and the tensile stresses in the bottom fibers of concrete taking case 2 as a reference.

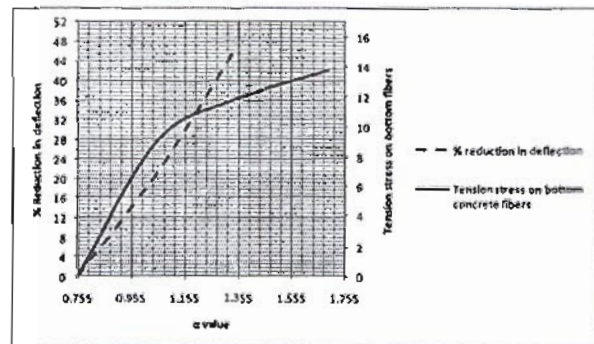

Figure (13), Relation between α , %Reduction in deflection and Tensile stresses in the bottom fibers.

From figure (13), as the composite stiffness factor α increases the slope of the tension stresses at the bottom fibers decreases, while the slope of the Reduction percent in deflection increases. This behavior is correct so long as the tensile stresses are less than the allowed value at the bottom fibers of concrete in both Global directions. The optimum value of α can be achieved by completing the graphs in figure (13)

and getting the maximum value of reduction percent in deflection corresponding to the allowed tensile stress allowed by the code Figure (14).

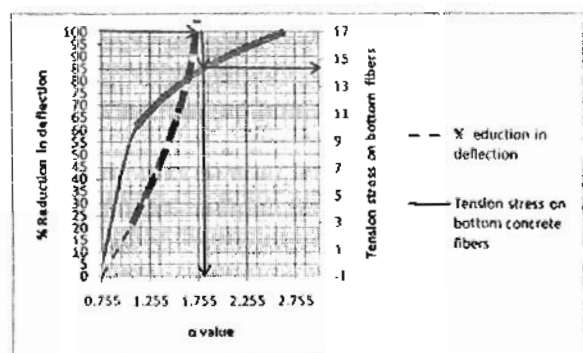

Figure (14), Getting the optimum value of α .

From figure (14), one can estimate that the optimum value of α as approximately 1.755, which corresponds to the following values:

- $t = 27$ cm.
- Stresses at the bottom fibers are approximately equal to 14 kg/cm^2 which are less than the allowed value in the code.
- Deflection reduction = 100% than that of case 2.

If the tensile stresses at the bottom fibers of the concrete increase than the allowed value by the code, the concrete will cracked, in which case a Nonlinear analysis is required where the cracks will initiate and the concrete in this zone will not be considered.

Conclusions and recommendations

- The behavior of composite beams supported on other composite beam in which the steel section is neither continuous over internal supports nor joined by full-strength rigid connections, is a paneled beam system.
- The best and most economic design for paneled composite beam systems is to consider the effective part of the reinforced concrete slab connecting the secondary beam to the main girder in the design.
- By increasing the slab thickness, the behavior of the paneled beam system will be improved. This behavior is acceptable until the Composite stiffness factor reaches its optimum

value. After which no improvement will occur until tension stresses reach the allowed limit in the code. The improvement will start to decrease due to the occurrence of cracks in concrete.

References

- [1] Johnson, R.B. (2004), Composite structures of steel and concrete, ISBN: 978-1-4051-0035-9, Blackwell Publishing.
- [2] Egyptian code of practice for steel construction and bridges (allowable stress design), code No. (205-2001).
- [3] Euro code 4 part 1.1 (2004).
- [4] David v. Hutton (2004), Fundamental of finite element analysis, McGraw-Hill companies.
- [5] SAP 2000 version 10 manual.
- [6] Egyptian code for design and construction of concrete structure ECCS (203-2001).