

APPLICATION OF A SOLAR DESICCANT/COLLECTOR SYSTEM FOR WATER RECOVERY FROM ATMOSPHERIC AIR

دراسة استخدام مجمع شمسي مزود بمجفف للحصول على الماء من الهواء الجوي

H.E Gad, A.M. Hamed and I.I. El-Sharkawy

Mechanical Power Engineering Department, Faculty of Engineering,
Mansoura University, Egypt

خلاصة:

يستعرض البحث نتائج لدراسة النظرية والتجارب العملية لاستخدام مجمع شمسي مسطح مزود بطبقة داخلية معرّجة من القماش مشربة بمحلول كلوريد الكالسيوم وذلك بغرض امتصاص رطوبة الجو ثم إعادة توليد البخار وتكثيفه على سطح زجاجي يعمل كمكثف. وقد تم عرض النموذج الرياضي للخاص بدراسة عملية إعادة توليد البخار ثم تم عرض النتائج النظرية ومقارنتها بالقياسات العملية. وقد تم إعداد الجهاز المعمل بمساحة قدرها 2 مترا مربعا، وتم تشغيل الجهاز في معمل الطاقة الشمسية بكلية الهندسة جامعة المنصورة. وقد تم قياس كل من الإشعاع الشمسي الساقط على سطح الوحدة المعملية ودرجات حرارة الجو والطبقة الداخلية بالإضافة إلى قياس درجة حرارة سطح الزجاج. وفي أثناء التجارب المعملية تم اختيار ترويد الوحدة بمكثف خارجي مساحته 2م² بغرض دراسة تأثيره على أداء الجهاز. وقد بينت التجارب المعملية إمكانية الحصول على حوالي 1.5 لتر من الماء يوميا لكل متر مربع. كما تم مقارنة النتائج النظرية مع القياسات المعملية وشرح أسباب التوافق والاختلاف بين النتائج المختلفة. كما تم مناقشة بعض مشاكل تشغيل مثل هذه الوحدات وكان من أهمها ضرورة الإحكام الجيد لها لتقليل تسرب البخار من الدليل للهواء الجوي أثناء عملية التوليد. كما بينت التجارب المعملية للتأثير السلبي لاستخدام مكثف خارجي وتم مناقشة أسباب ذلك.

ABSTRACT:

An integrated desiccant/solar collector system for production of fresh water from atmospheric air has been described. The solar driven system provided about 1.5 liter of fresh water per square meter per day. The system involves night absorption of water vapor from ambient air and simultaneous desiccant regeneration and water vapor condensation during the daytime. To enhance the mass transfer surface, a thick corrugated layer of cloth was used as a bed carrying the liquid absorbent. In the nocturnal phase of operation, air is allowed to penetrate the desiccant bed. The forced airflow is driven by special fans supported on one side of the desiccant / solar collector unit. In this study, the effect of different parameters on the absorption and regeneration processes was discussed, and the operational conditions for the proposed equipment were found. Radiation intensity, ambient temperature, bed temperature and temperature of glass surface are recorded. Also, the productivity of the system has been plotted along the daytime, for given operating conditions. A mathematical model is prepared where its output is compared with the analyzed experimental data. The experimental set-up, which has a square collection area of 2 m² was operated at the Solar Energy Application Laboratory, Mansoura University, Faculty of Engineering.

Key words: Absorption, regeneration, desiccant, water recovery, atmospheric air

NOMENCLATURE:

A, B, a, b	empirical constants of equations 15, 6	τ_g	Transmissivity of the glass cover
a_0, a_1, b_0, b_1	empirical constants of equations 13, 14	σ	Stefan-Boltzman constant = $5.67 \times 10^{-8} \text{ W/m}^2 \cdot \text{K}^4$
C	thermal capacity, $\text{J/m}^2 \cdot \text{C}$	η	operation efficiency of the system.
F	shape factor	Δy	air gap thickness, m
H	incident solar radiation, W/m^2 .	Δt	time interval, s
H	heat transfer coefficient, $\text{W/m}^2 \cdot \text{C}$	Subscripts	
K	thermal conductivity, $\text{W/m} \cdot \text{C}$	a	ambient, air gap

L	latent heat of water, J/kg	B	system base
M	mass of solution, kg	b	bed
P	instantaneous system productivity, kg/m ² -s	bg	between bed and glass
P	vapor pressure, MN/m ²	c	conduction
Q	rate of heat transfer, W/m ²	D	desiccant
T	temperature, °C	f	final condition
V	wind speed, km/hr	e	evaporation
Greek		g	glass cover
α	average absorptivity.	ga	between glass and ambient
β	mass transfer coefficient kg/m ² . mm. Hg. hr	g sky	between glass and sky
δ	thickness	i	initial condition.
τ	time, s	s	bed surface

1. INTRODUCTION :

Fresh water supply is one of the most limiting conditions for population in arid regions. The problem of providing arid areas with fresh water can be solved by the following methods [1].

- 1- Transportation of water from other locations,
- 2- Desalination of saline water (ground and underground) and
- 3- Extraction of water from atmospheric air

Transportation of water through these regions is usually very expensive. On the other hand, desalination of water depends on the presence of saline water resources, which are usually rare in arid regions. Atmospheric air, which contains about 14000 km³ of water vapor [2], is a new and renewable water resource.

Extraction of water from atmospheric air can be accomplished by two different methods. The first method is by cooling moist air to a temperature lower than the air dew point. The second one is by absorbing water vapor from moist air using a solid or a liquid desiccant, with subsequent recovery of the extracted water by heating the desiccant and condensing the evaporated water.

One of the first works dealing with water extraction from atmospheric air was published in Russia [3]. An apparatus consisting of a system of vertical and inclined channels in the earth to collect water from atmospheric air by cooling moist air to a temperature lower than its dew point has been proposed. Hall [4], proposed a cycle for production of water from atmospheric air by absorption using ethylene glycol as a liquid desiccant with subsequent recovery in a solar still. The effect of temperature and humidity on the recovered water was studied and presented on the composition- psychometric chart, but the paper does not provide any information about the mass of recovered water. Sofrata [5], constructed a non-conventional system to collect water from the outdoor air based on adsorption-desorption process using a solid desiccant. Also, the paper has discussed the feasibility of application of air conditioning systems for collecting water from moist air by cooling it to a temperature lower than the dew point. Alayli [6], used a typical S-shaped composite material for absorption of moisture from atmospheric air with subsequent regeneration using solar energy. Hamed [7], carried an experimental study on water extraction from atmospheric air using solar energy by two different methods. The first method was based on cooling moist air to a temperature lower than the air dew point using a solar LiBr-H₂O absorption cooling system. The second one was

based on absorption of moisture from atmospheric air during night using calcium chloride solution as a liquid desiccant with subsequent recovery of absorbed water, at daytime. As a result of this study, the second method was recommended as a most suitable application of solar energy for water recovery from air. For climatic conditions with high temperature and humidity, such those in U.A.E. coastal regions, Khalil [8], investigated the process of cooling and dehumidification of air conditioning as a possible technique for obtaining fresh water. Also, the process was analyzed and the operating parameters were optimized to maximize the condense yield. Awad et al [9], described the application of a simple vapor-compression refrigeration cycle for cooling moist air to a temperature lower than its dew point where condensation of moisture occurs. Also, theoretical relation for selection of optimum cooling temperature was developed. Gandhidasan and Abualhameel [10], presented an analytical procedure for calculation of mass of absorbed water from atmospheric air using liquid desiccant as a function of meteorological data and initial desiccant conditions.

Review of literature shows that although the cooling process and absorption-regeneration method seem to be feasible solution for the problem of obtaining water from air, however, multiple energy conversion processes are needed when cooling is applied. Moreover, a large volume of air must be cooled to lower temperature and this will increase the energy losses in the process. On the other hand, in absorption-regeneration method heat is directly used to heat the absorbent and efficient design of the system will reduce the amount of heat lost to the surrounding.

In the present work, a theoretical and experimental investigation on the application of corrugated surface of desiccant bed, which is made of thick layer of cloth carrying calcium chloride solution as the absorbent is introduced. Also, the study aims to evaluate the effect of different parameters on the productivity of the system during regeneration time. These parameters include the system design characteristics and the outside driving parameters, which are radiation intensity and ambient temperature.

2. THEORETICAL ANALYSIS:

Factors affecting absorption process

The mass of moisture, m , absorbed from atmospheric air depends mainly on the atmospheric conditions (temperature and vapor pressure), desiccant properties, absorption area, A , absorption time, Δt , and mass transfer coefficient, β , according to the following relation [7].

$$m = \beta A \Delta p \Delta t \quad (1)$$

where Δp is the vapor pressure difference between ambient air and desiccant surface, which can be expressed as

$$\Delta p = p_w - p_D \quad (2)$$

For a given absorption period, the mass of absorbed water vapor can be increased by increasing any of the following three parameters, namely mass transfer coefficient absorption area or vapor pressure difference (equation 1). For a given concentration range of solution and certain operating conditions of absorption, mass transfer coefficient and vapor pressure difference will be nearly constant. However, absorption process can be enhanced by increasing the area of absorption, A . When flat plate collector containing the desiccant bed is applied for regeneration process, bed area in the collector can be increased by corrugation of the bed surface as shown in Fig. 1.

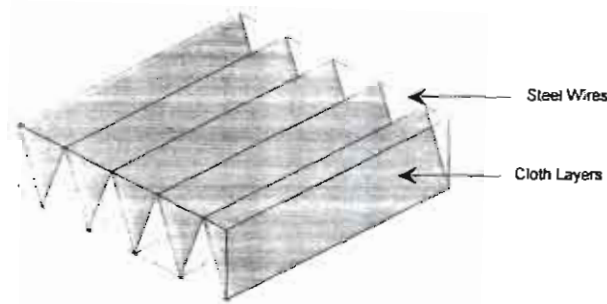

Fig. 1. General view of corrugated bed

Regeneration mathematical model :

The formulation of regeneration mathematical model is based on thermal analysis of the proposed system. The system energy flow diagram is illustrated in Fig. 2.

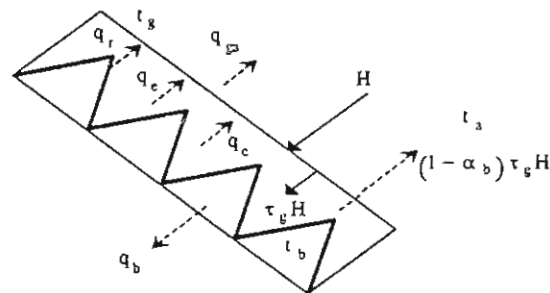

Fig. 2. Energy flow diagram for the proposed system.

The unit area of glass cover receives solar radiation at an intensity H . The incident solar radiation is transmitted through the glass cover at a rate of $\tau_g H$, part of radiation is absorbed in the glass at a rate of $\alpha_g H$ and the rest is reflected to the surrounding. The bed absorbs and reflects heat at rates of $\alpha_b \tau_g H$ and $(1 - \alpha_b) \tau_g H$, respectively. Heat lost from the bed to the glass cover by radiation q_r , evaporation q_e and by conduction q_c through the air gap where as, heat lost from the system base and sides and from the glass cover to the surrounding are q_b and q_{ga} , respectively.

Referring to Fig. 2, the heat balance equations of the glass cover and the system as a whole can be expressed by the following relations:

$$q_{ga} = q_r + q_e + q_c + \alpha_g H \quad (3)$$

$$\alpha_g H + \alpha_b \tau_g H = q_{ga} + q_b + C_s \left(\frac{dt_b}{d\tau} \right) \quad (4)$$

Values of q_{ga} , q_r , q_e , q_c and q_b are expressed as given by Dunkel [11].

$$q_{ga} = h_{ga} (t_g - t_a) + F_{g-sky} \sigma [(t_g + 273)^4 - (t_a + 263)^4] \quad (5)$$

h_{ga} can be calculated as given by Mc Adams [12],

$$h_{ga} = a + b(v)^n \quad (6)$$

Where a, b and n are coefficients which depend on the roughness of the cover and wind speed.

$$q_c = K_s \frac{(t_s - t_g)}{\Delta y} \quad (7)$$

$$q_r = F_{hg} \sigma [(t_s + 273)^4 - (t_g + 273)^4] \quad (8)$$

$$q_e = 0.0061 \left[(t_b - t_g) + \left(\frac{p_b - p_g}{0.265 - p_b} \right) (t_b + 273) \right]^{1/3} (p_b - p_g) L_b \quad (9)$$

$$q_B = h_B (t_b - t_g) \quad (10)$$

In the preceding equations q_r and q_e are calculated based on the bed surface temperature which can be evaluated as follows:

$$t_s = t_b + \alpha_b \tau_g H \left(\frac{\delta_b}{2k_b} \right) \quad (11)$$

Where t_s , t_b are the surface and average bed temperatures, respectively and δ_b , k_b are the bed thickness and thermal conductivity, respectively.

Evaporative heat transfer is calculated according to the average bed temperature and average solution concentration, where vapor pressure on the bed surface can be calculated as a function of solution temperature within temperature range from 10 to 65°C and concentration range from 20% to 50% according to the following equations [1].

$$\ln(p_b) = A(x) - \frac{B(x)}{t_b + 111.96} \quad (12)$$

Where p_b in mm Hg, t_b in °C, A(x) and B(x) are regression dependent parameters, which can be expressed as a linear function of concentration according to the following relations:

$$A(x) = a_0 + a_1 x \quad (13)$$

$$B(x) = b_0 + b_1 x \quad (14)$$

Where

$a_0 = 10.0624$	$a_1 = 4.4674$
$b_0 = 739.828$	$b_1 = 1450.96$

During regeneration process the bed temperatures increases to values of about 100 °C, therefore, an expression for deriving the vapor pressure of solution for temperature range from 60 to 100 °C is developed in the following form:

$$\ln(p_b) = A - \frac{B}{(t_b + 273)} \quad (15)$$

Where A, B are regression constants. Values of A, B and their associated concentration are given in table I (Appendix).

The rate of change in average bed temperature can be evaluated from equation (4) where quasi-steady state condition is considered, while the instantaneous system productivity can be evaluated using the following relation:

$$P = \frac{q_e}{L_b} \quad (16)$$

The average bed concentration at the end of a certain time interval $\Delta\tau$ can be calculated from the following equations:

$$M_f = M_i - P \times \Delta\tau \quad (17)$$

$$M_f X_f = M_i X_i = \text{const.} \quad (18)$$

The operation efficiency of the system can be defined as:

$$\eta = \frac{\sum q_e}{\sum H} \quad (19)$$

3. EXPERIMENTAL STUDY:

Experimental Set-up

The aim of the experimental work is to evaluate the performance of the system in Egyptian climate with application of CaCl_2 , which is the most available and cheap absorbent, as the working desiccant. Also, it is interested to evaluate the theoretical results of the mathematical model by comparison with the experimental data. In the same time, system operation problems must be highlighted.

To design an operating system, design data must be carefully selected considering the ambient conditions and absorbent thermo-physical properties. Some preliminary experiments were carried out to obtain the average value of the mass transfer coefficient and the proper thickness of the cloth layer, which forms the bed. The bed thickness is selected such that when solution reaches the saturation condition, corresponding to vapor pressure in the ambient atmosphere, it must be able to carry all the mass of weak solution at the end of absorption process, i.e. falling of liquid drops from the bed must be avoided.

Figure 3 shows a schematic diagram of the experimental apparatus, it consists mainly of three parts, flat plate collector with a movable glass cover, corrugated bed and an air-cooled condenser of two parallel flat plates.

- 1- Flat plate collector.
- 2- Glass cover.
- 3- Fans openings.
- 4- Collected water channel.
- 5- Foam (Isolation).
- 6- Aluminum sheets.
- 7- Steel sheets.
- 8- Metallic frame.
- 9- Collected water tube of condenser.
- 10- Collected water tube of collector.
- 11- Graduated Flask.
- 12- Flat plate condenser.
- 13- Connected channel.
- 14- Condenser support.
- 15- Condenser opening.
- 16- Collector support.
- 17- Glass cover support.

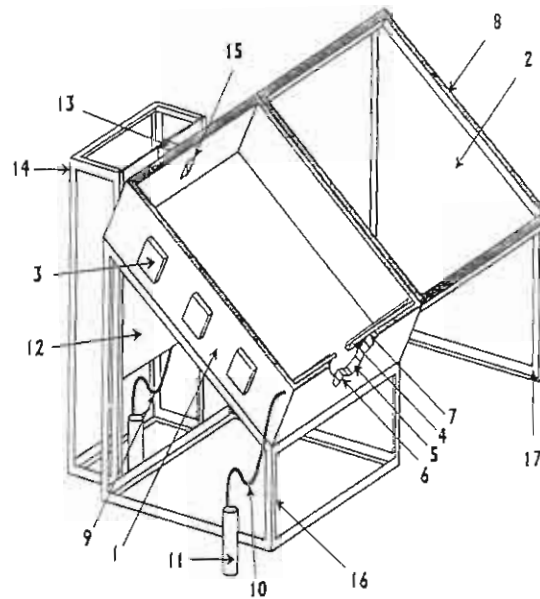

Fig. 3 A schematic diagram of the experimental apparatus.

The inner surface of the collector is made of 0.5 mm thickness steel sheets to form, by welding, a box having cross section of (1.42 x 1.42 m) and 0.3 m height.

Three square openings of (0.2 x 0.2 m) are distributed on one side of the box. In each opening, a fan of 10-Watt power is supported. The box is isolated by a high density foam of 0.05 m thickness covered with an aluminum sheets which form, by riveting, the outside case of the apparatus. A glass cover which has a square cross sectional area of 2 m² and 6 mm thickness is supported by a metallic frame to form the apparatus upper side. The frame is hinged with the box from one side. To support the cloth layers, which are called bed, a metallic frame which is made of steel wires is used (Fig. 1). The bed height is 0.2 m while the horizontal distance between each two successive steel wires is 5 cm. The proposed corrugation increases the absorption area to about 4.1 times of its projected area. A steel frame with a tilt angle of 30° supports the apparatus. General view of the experimental apparatus is illustrated in Fig. 4.

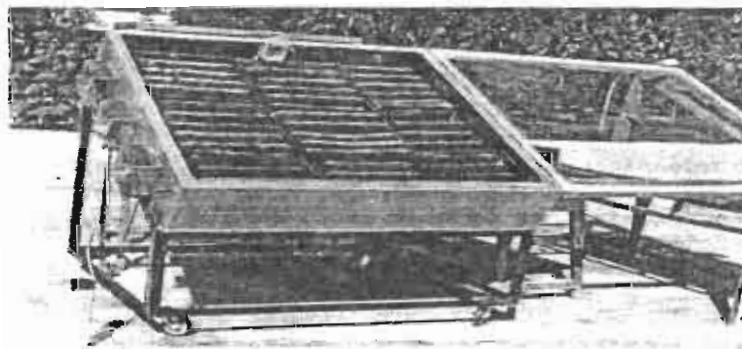

Fig. 4. General view of the experimental apparatus

During the experimental work, an air cooled surface condenser with two parallel flat plates and total surface area of 2 m^2 is connected to the solar collector from the north direction side through a small steel duct (Fig. 3) The condenser is made of steel sheets of 0.5 mm thickness. At the bottom side of condenser, a condensate collection flask is located. The condenser is connected to the system to evaluate its effect on the system productivity and operation. System design parameters are given in appendix, table II.

Experimental procedure and system operation

During absorption process, the bed carrying the strong desiccant is allowed to absorb water vapor from air at night period where the glass cover of the collector is opened and absorption is carried out naturally or by forced convection through the operation of fans which are supported on one side of the collector (Fig. 3). When the absorption stops (at the end of night), the system glass cover is closed with all the other openings connecting the system to the surrounding atmosphere except for the condensate collection opening. At the daytime, the incident solar radiation is absorbed by the black coated bed and consequently the bed temperature increases, as a result the vapor pressure of the solution on the bed surface increases and vapor pressure difference between the bed surface and glass cover is created. At this moment, evaporation of moisture from the bed with subsequent condensation on the glass surface is carried out. Evaporation and condensation continue until the vapor pressure on the bed surface is equal to that on the glass surface. At the end of the daytime the glass cover is opened and the bed is allowed to cool until the vapor pressure on its surface decreases to a value lower than that of the ambient air where absorption started again and the cycle is repeated.

Temperatures at different points in the system are recorded using copper-constantan thermocouples, which are connected to a temperature recorder. Bed surface and inner temperatures are measured at different locations distributed over the collector area. The glass mean surface temperature is obtained from the average readings of three diagonally supported thermocouples. Dry and wet bulb temperatures of the stream entering the condenser are also recorded using dry and wet bulb thermocouples. During the experimental test, ambient temperature and radiation intensity is also recorded. Graduated glass flask is located at the condensate collection point as shown in Fig. 4. The total mass of absorbed or evaporated water is obtained by measuring the weight of the bed at the end of absorption and regeneration processes. Variation of solution concentration during regeneration time is evaluated by knowledge of the hourly mass of collected vapor as given in equation (18).

4. RESULTS AND DISCUSSION :

Experimental tests were carried out in two seasons during the period from October 1998 to June 1999. Application of flat plate condenser, which is specially designed and fabricated to operate with the desiccant collector, is experimentally investigated in some selected days of system operation. Theoretical results of the regeneration model are plotted with the corresponding field recorded data. Hourly recorded data and calculated results are presented in terms of different measured temperatures (ambient, glass, bed and condenser), solar radiation, collected condensate, evaporated water from the bed and measured relative humidity of stream entering the condenser.

Typical results of hourly variation of ambient, condenser, glass surface and bed temperatures for different days of system operation are presented graphically in Fig. 5.

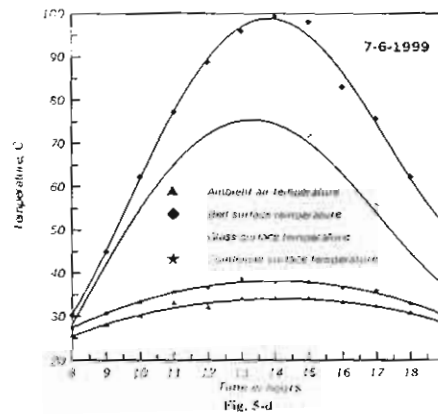
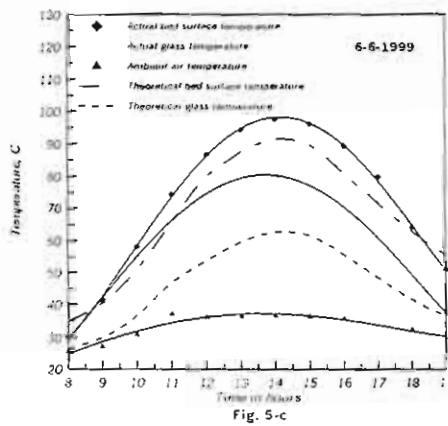
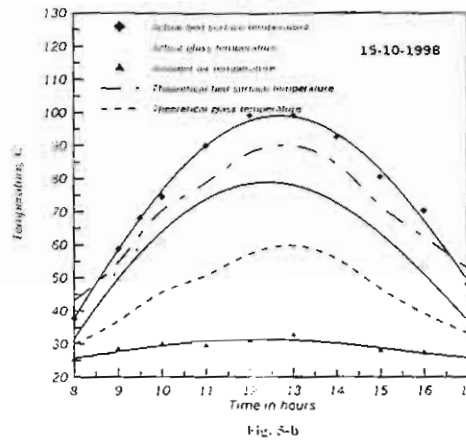
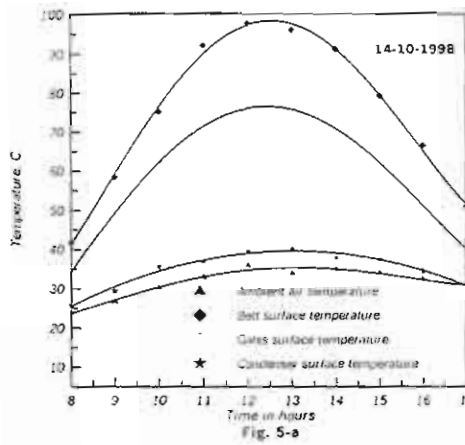

Fig. 5 Hourly variation of ambient, condenser, glass surface and bed temperatures

Relatively high values of bed temperatures (about 100°C) can be observed after noontime. It is clear that the difference between bed temperature and glass surface temperature increases gradually and reaches its maximum value nearly at the period of maximum bed temperature, then, decreases again at the end of the day time. Calculated values of the bed temperature show good agreement with that recorded during the experiments (Fig. 5-b, 5.c). The agreement between recorded temperatures of the glass cover and that calculated from the theoretical model seems to be much lower. This poor agreement can be explained as follows: the evaporative heat transfer rate from bed to glass is calculated according to the average bed temperature which is relatively lower than the bed surface temperature, therefore, the calculated heat added to glass will be lower than the actual values. However, calculated values of temperatures for bed and glass surface have the same trend of the actually recorded data.

Figure 6 shows the variation of radiation intensity on the collector surface with the system productivity during the daytime. The hourly values of the system productivity are presented with the corresponding values of evaporated water form the bed and the theoretical results of the mathematical model. The daily-evaporated mass of water is evaluated from the difference of masses of the bed, where the mass of the bed is measured at the end of absorption and regeneration respectively. Hourly values of evaporated water are estimated from the total daily value, which is divided in the percentage of the hourly collected masses of water. The

difference between the collected and evaporated masses of water is due to leak of vapor from the collector (from about 8% to about 30%). Evaluation of the mass of lost water vapor due to leakage is important, where the apparent conditions of such systems show proper tightening but, in most cases, leakage can not be easily avoided. Therefore, perfect tightening of this system as well as the solar still is extremely important. It can be observed that the trend of system productivity follows that of radiation intensity with lag of about one hour (Fig. 6.b, 6.c). Also, lag of calculated values of system productivity with respect to actual data can be explained as follows: in the morning hours, the bed surface temperature rapidly increases and consequently the vapor pressure of water on the bed surface. Where as the productivity is calculated on the basis of average bed temperature which increases in a lower rate compared with surface temperature. On the other hand, after noon, theoretical values of productivity exceed that actually recorded. This due to increase in desiccant concentration on the bed surface due to evaporation of water while the average solution concentration which is considered in calculation, is lower and consequently the vapor pressure of the desiccant will be higher in the after noon period.

Typical results of the accumulated values of evaporated water, collected condensate and theoretical productivity are illustrated in Fig. 7. When the condenser is applied (Fig. 7-a, 7-d), mass of collected water due to condensation of part of water vapor inside the condenser is also demonstrated. The condenser daily productivity is evaluated as about 13% of the total daily productivity of the system.

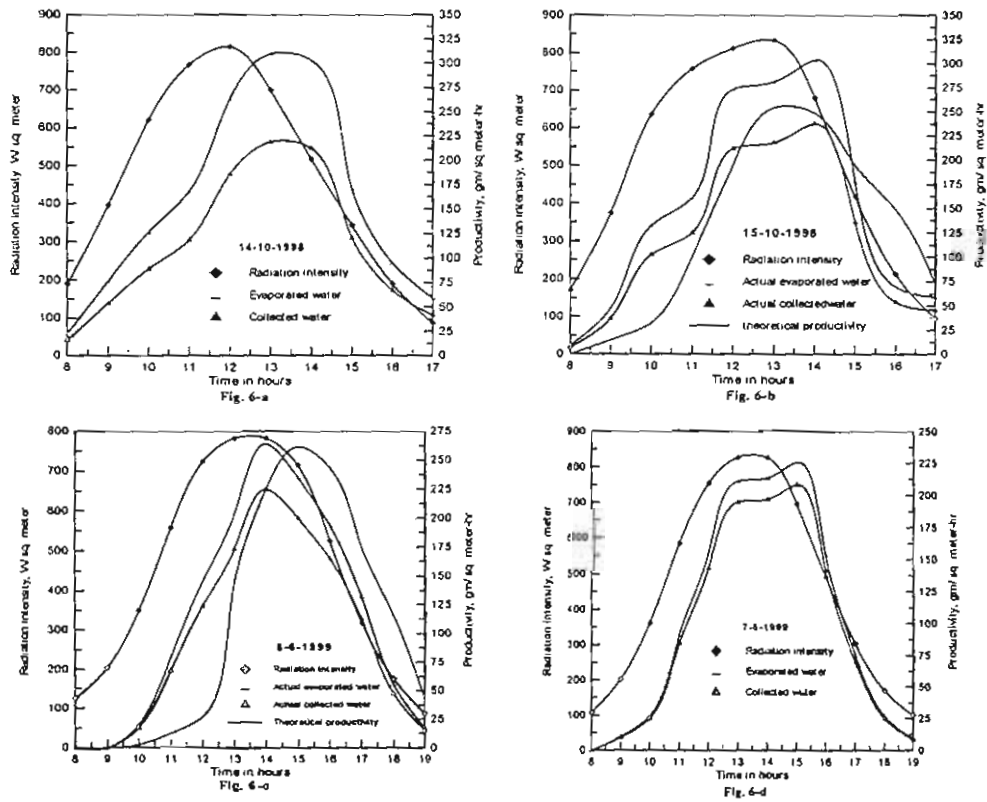

Fig. 6 Hourly values of radiation intensity, evaporated water and collected condensate.

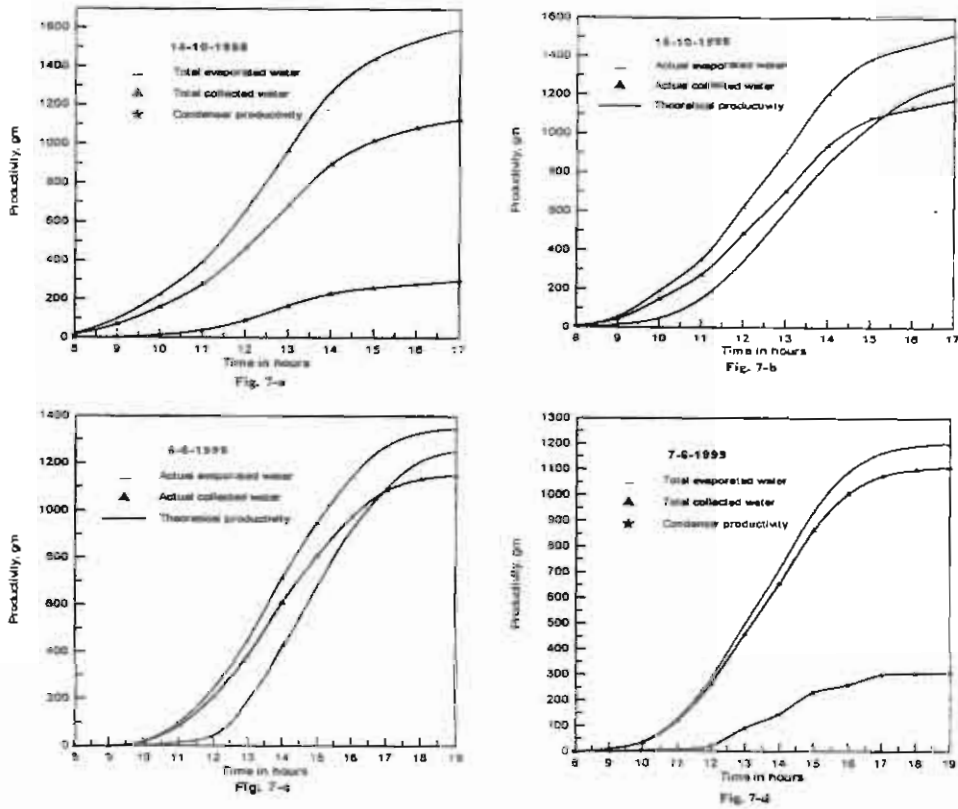

Fig. 7. Hourly accumulated productivity and evaporated water

Typical results of system operation for four days are tabulated below.

TABLE (III) SYSTEM OPERATING CONDITIONS

Condition	Date	14/10/1998 With Condenser	15/10/1998 Without Condenser	6/6/1999 Without Condenser	7/6/1999 with condenser
Absorbed water in the previous night, Kg/m ²		-	1.4	1.138	1.274
Initial concentration, %		30	31	31.5	31.8
final concentration, %		40.7	41.7	40.7	40
Initial mass of solution, Kg/m ²		6.076	5.881	5.895	5.321
Final mass of solution, Kg/m ²		4.481	4.37	4.547	4.619
Collected water, Kg/m ²		1.124	1.175	1.148	1.109
Lost water, Kg/m ²		0.471	0.34	0.2	0.094
Evaporated water, Kg/m ²		1.595	1.515	1.348	1.202
Daily total radiation J/m ²		16.646x10 ⁶	17.959x10 ⁶	19.247x10 ⁶	19.47x10 ⁶
Overall efficiency		17.78	17.24	14	13.3

It can be observed that the operating concentration range for the given climatic condition ranges from 30% to 40%, whereas the average mass of solution per m^2 of system is around 6 kg with an initial concentration of 30%. This means that about 2.25 kg dry $CaCl_2$ with a concentration of 80%, which is commercially available in the market is required per m^2 collector area. Also, system overall daily efficiency of about 13% to 17% are given in table III. The effect of condenser in the system performance can be evaluated by comparison of the results of two operating days (6.6.1999 and 7.6.1999), where the initial mass of solution for the two days are nearly the same. The overall efficiency decreases from 14% to 13.3% when the condenser is applied. In other words, a percentage reduction in the system efficiency of about 5% results when the condenser is connected to the collector.

The negative effect of condenser can be explained with the help of Fig. 8, which displays the variation of relative humidity of stream entering the condenser. As shown in figure, around the noon time, the relative humidity of air at condenser inlet is extremely low and a large part of heat must be rejected to reach saturation condition, at which condensation starts. This means that part of heat is rejected from the system through the condenser surface to the ambient atmosphere. On the other hand, glass surface functions as a heat addition surface on which condensation takes place and the net heat gain through glass is positive, whereas the condenser surface rejects heat only.

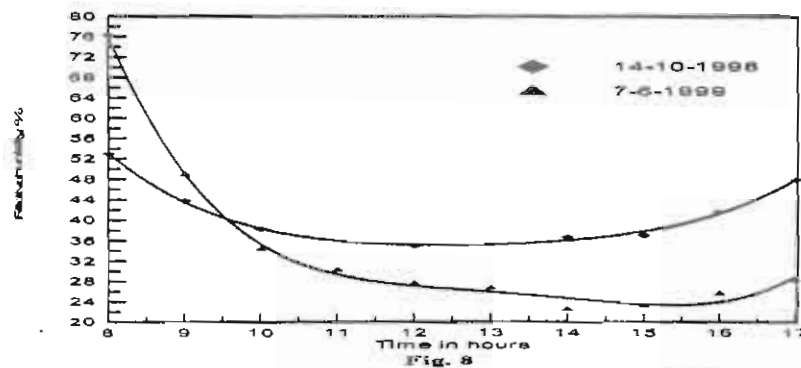

Fig. 8. Hourly values of relative humidity at condenser inlet

5. CONCLUSIONS :

Application of desiccant/collector system with a thick corrugated layer of blacked cloth to absorb water vapor at night from atmospheric air with a subsequent regeneration during the daytime, using solar energy, is investigated. Actual recorded results show that the solar operated system can provide about 1.5 liter of fresh water per square meter per day in moderate climatic conditions. Also, system operation and associated problems are discussed. System efficiency is defined and values of more than 17% are recorded. Application of additional condenser with the system reduces the efficiency. The effect of ambient conditions on the system performance is also demonstrated. Comparison of theoretical results of the regeneration model with field recorded data is presented and discussed. Design of tightly closed system seems to be extremely important to minimize vapor leak during regeneration.

REFERENCES:

- 1- Hamed, A.M., " Absorption-regeneration cycle for production of water from air- Theoretical approach", Accepted for publication, Renewable Energy Journal, 1999.
- 2- Obrezkova, V.E., "Hydro-energy" Energoatomezdat, Moscow, 1988.
- 3- Tygarinov, V.V., " An equipment for collecting water from air", patent, No. 69751, In Russia, 1947.

- 4- Hall, R.C., "Production of water from the atmosphere by absorption with subsequent recovery in a solar still", Solar Energy, 10, pp. 42-45, 1966.
- 5- Sofrata, H., "Non-conventional system for water collection" Proc. of solar desalination workshop. 2, pp. 71-87, 1981.
- 6- Alayli, Y., Hadji, N.E. and Leblond, J., "A new process for the extraction of water from air", Desalination, No. 67, pp. 227-229, 1987.
- 7- Hamed, A.M., "Non-conventional method for collecting water from air using solar energy", Ph.D. Thesis, Russian Academy of Science, 1993.
- 8- Khalil, A., "Dehumidification of atmospheric air as a potential source of fresh water in the U.A.E." Desalination, No. 93, pp. 587-596, 1993.
- 9- Awad, M.M., Sultan, A.A and Abd El Raouf, M.M., 'Using refrigeration systems to extract water from moist air' Proc. of the first UAE conference on air conditioning in the Gulf. ACG. 96, 1996.
- 10- Gandhidasan, P. and Abualhamayel, H. I., "Water recovery from atmosphere" WREC. pp. 745-748, 1996.
- 11- Dunkel, R.V. "The roof type still and a multiple effect diffusion still" international heat transfer conference, University of Colorado, U.S.A., part 5, 895-902, 19961.
- 12- Mc Adams, W.H., Heat Transmission, McGraw-Hill Book Company, 1954.
- 13- Elsayed, M.M., "Comparison of transient performance predictions of a solar-operated diffusion-type still with a roof-type still" Journal of solar engineering, Vol. 105, pp. 23-28, 1983.

APPENDIX :

TABLE (I) REGRESSION CONSTANTS OF EQUATION 15.

Concentration %	A	B
20	19.9418	5053.95
25	20.3898	5244.51
30	19.9915	5133.02
35	20.1957	5244.15
40	20.4864	5411.75
45	19.591	5168.25
50	20.8764	5708.42

TABLE (II) DESIGN PARAMETERS OF THE SYSTEM

Design parameters	Symbol	Value
Glass cover absorptivity	α_g	0.12
Glass transmissivity	τ_g	0.87
Bed absorptivity	α_b	0.87
Bed thermal conductivity	K_b	0.3 W/m-°C
System thermal capacity	C_s	$10^3 J/m^2$
Heat transfer coefficient between system based and sides except glass cover and ambient	H_b	2 W/m ² -°C
Air gap thermal conductivity	K_a	0.03 W/m-°C
Air gap thickness	Δy	0.10 m
Wind velocity	V	5 km/hr.

The properties of water and its vapor can be calculated using the following equations [13].

$$\log_{10}(p_b) = -3.21254 + 3.13619 \times 10^{-2} t_b - 1.22512 \times 10^{-4} t_b^2 + 3.63841 \times 10^{-7} t_b^3 - 5.67607 \times 10^{-10} t_b^4$$

$$L_b = 10^3 (2501.67 - 2.389 t_b)$$