

Liquids cooling of electronic heat sources

تبريد المصادر الحرارية الإلكترونية بالسوائل

A.E. Kabeel, A. K. Mahmoud and F. H. El Dosary

Faculty of Engineering, Tanta University, Tanta, Egypt.

الخلاصة:

لقد أصبح تبريد الاجهزة الالكترونية من اهميات هذا العصر نتيجة للتطور السريع في تصميمها وصغر حجمها. استخدام السوائل في التبريد اصبح الطريقة الاكثر فعالية وذلك لمعامل انتقال الحرارة العالي لها بالمقارنة بالهواء المستخدم سابقا. يقدم هذا البحث دراسة نظرية ومعملية لتبريد للجهزة الالكترونية باستخدام السوائل. من اجل ذلك تم تصميم جهاز معملية يتكون من ثلاث مصادر حرارية حيث يدخل المائع من فتحة في الاعلى للصندوق الذي يحتوى على المصادر ويخرج من الجانبين عند ارتفاعات مختلفة. تمت استخلاص النتائج المعملية عند ظروف تشغيل مختلفة وتم دراسة تأثير كمية السريان ومعدل السريان الحراري على درجات الحرارة للمصادر الحرارية وكذلك تأثير فتحة الخروج. اوضحت الدراسة ان خروج السائل من فتحة الخروج السفلى والتي تقع في مستوى السطح العلوي للمصادر الحرارية هي الافضل وان درجة حرارة المصدر الحرارة المقابل لفتحة الدخول اقل من درجة حرارة المصدرين الاخرين. تم استنتاج علاقة معملية بين رقم Reynolds ورقم Nusselt والتي يمكن استخدامها مباشرة في مثل هذه الظروف. كما اوضحت النتائج ان توزيع درجات الحرارة للزيت المستخدم في هذه الدراسة (زيت محول كهربائي) تعطي نتائج افضل استخدام الماء في التبريد هذا بالإضافة لمزيد عدم توصيلة للكهرباء. كما اوضحت النتائج توافق بين النتائج المعملية والنتائج النظرية بنسبة مرضية.

ABSTRACT

The cooling of electronic parts has becomes a majour challenge in recent years due to the advancement in the design of faster and smaller components. The use of liquid coolant has become more attractive due to the higher heat transfer coefficient achieved as compared to air-cooling. Present work details the numerical and experimental analysis of cooling heat sources using water and dielectric oil (transformer oil). The experimental data were carried out at different flow rate and different heat flux. The flow is inlet from the upper surface of the test section and exit from the sides. The effect of flow exit section was studied for different sections. Results shows that the case of the flow exit from the lower section which in the same level of the higher surface of the discrete heat sources is the best. Results shows also that the transformer oil is given a good coolant effect compared with water. Empirical correlation development from experimental to calculate the Nu. Results shows also good agreement between the theoretical and experimental results.

Keywords: Discreate heat sources, Heat Transfer, Electronic cooling.

INTRODUCTION

For over 60 years, thermal management of electronic equipment has been the major obstacle in developing advanced electronic systems. Especially, for today's modern electronic systems that

play a crucial role in vital systems of health, defense and economy, the thermal control becomes extremely critical. The improvements in the thermal analysis and design lead to the faster, more reliable and smaller microelectronic devices.

The cooling of electronic parts has become a major challenge in recent times due to the advancements in the design of faster and smaller components. As a result, different cooling technologies have been developed to efficiently remove the heat from these components. The use of a liquid coolant has become attractive due to the higher heat transfer coefficient achieved as compared to air-cooling. Coolants are used in both single phase and two-phase applications. In A single phase cooling the heat source in the electronics system is attached to the heat exchanger. Liquid coolants are also used in two-phase systems, such as heat pipes, thermo-siphons, sub-cooled boiling, spray cooling, and direct immersion systems requirements for a liquid Coolant for electronics [1]

The rapid development in the design of electronic packages for modern high-speed computers has led to the demand for new and reliable methods of chip cooling. As stated by Mahalingam and Berg [2], the averaged dissipating heat flux can be up to 25 W/cm² for high-speed electronic components. However, the conventional natural or forced convection cooling methods are only capable of removing small heat fluxes per unit temperature difference, about 0.001 W/cm²C by natural convection to air, 0.01 W/cm²C by forced convection to air, and 0.1 W/cm² C by forced convection to liquid [3]. In response to these demands, different highly effective cooling techniques have been used in the past to obtain heat transfer enhancement with a minimum of frictional losses, including a variety of passive or active cooling techniques.

The numerical investigation on flow field and heat transfer characteristics of two successive porous-block mounted heat sources subjected to pulsating channel flow was studied by Po-Chuan Huang et al [4]. Extensive time-dependent flow and temperature data are calculated and

averaged over a pulsating cycle in a periodic steady state. The basic interaction phenomena between the porous substrate and the fluid region, as well as the action of pulsation on the transport process are scrutinized within that study. Steady-state experiments are performed to study general convective heat transfer from an in-line four simulated electronic chips in a vertical rectangular channel using water as the working fluid [5]. Their experiment has been performed to investigate the natural convection heat transfer coupled with the effect of thermal conduction from a steel plate with discrete heat sources [6]. The behavior and heat transfer enhancement of a particular nanofluid, Al₂O₃ nanoparticle- water mixture, flowing inside a closed system that is destined for cooling of microprocessors or other electronic components was investigated by Nguyen et al [7]. The development of a novel cooling strategy for electronic packages was studied by Wits et al [8]. Two-dimensional forced convection heat transfer between two plates with flush-mounted discrete heat sources on one plate to simulate electronics cooling is studied numerically using a finite difference method [9]. The effects of rotation on natural convection cooling from three rows of heat sources in a rectangular cavity was studied by Jin et al [10]. A free jet of high Prandtl number fluid impinging perpendicularly on a solid substrate of finite thickness containing small discrete heat sources on the opposite surface has been analyzed by Antonio et al [11]. Steady-state experiments are performed to study general convective heat transfer from an in-line four simulated electronic chips in a vertical rectangular channel using water as the working fluid [12]. Numerical simulation of conjugate, turbulent mixed convection heat transfer in a vertical channel with discrete heat sources was studied by Roy et al [13]. Investigation of mixed convection heat transfer in a horizontal channel with discrete heat sources at the top and at the bottom was studied by Dogan et al [14]. Laminar-mixed convection of a dielectric fluid contained in a two-dimensional enclosure is

investigated [15]. Spray cooling is a very complex phenomena that is of increasing technological interest for electronic cooling and other high heat flux applications since much higher heat transfer rates compared to boiling can be achieved using relatively little fluid [16]. An experimental study of cooling an array of multiple heat sources simulating electronic equipment by a single row of slot air jets positioned above a critical row (row having maximum heat dissipation rate) of the array was conducted [17]

Although some researcher has studied the use of liquid to the enhancement of heat transfer from the heat sources, they present few cases of this use. In the present study, IC's components "chips" is idealized as smooth rectangular blocks with uniform thermal conductivity and constant heat flux. The aim of the present work is to use liquid (water and dielectrics oil) for cooling the heat sources. The study will carried out at different exit conditions, different flow rate, and different heat flux. Also, this paper presents the effect of outlet ports positions for water and transformer oil to investigate the best position of exit flow..

THE EXPERIMENTAL TEST RIG

The details of the experimental test rig are shown in Fig. (1). It consists of a the test section, cooling fluid feed back tank, flowmeter (2), the cooling chamber (6), headers (5), heat exchanger (7), thermocouples (11), temperature indicator (12), Ammeter (13), Voltage transformer (Variec) (14) and power supply. There were altogether two flow loops. The test

section was made of Aluminum bars. The cooling chamber (2) was made of Acrylic. The chips (3) were made of copper sheet as the box. The heat exchanger was made of galvanized steel and the tubes made from copper 6.25mm in diameter.

The test section was consisted of two parts which were the flow channel and the heater assembly modules. The width of the flow channel was 75 mm, height was 6.25mm and total length of 400mm. There were three heaters modules simulating three electronic chips embedded in the base piece of the test section. The dimension for the heater assembly module was 10 mm in diameter, 10cm length and 200W power. Two different fluids used in this work, water and oil (transformer oil). The flow rate used 2, 1.5, 1 and 0.5 L/min. The heat flux 200, 150, 100 and 50 W.

Five thermocouples, J-type (8) are fixed on the walls of each chip to measure its average temperature. Also, four thermocouples are fixed on inlet and outlet of cooling chamber and heatexchanger.

For determining the liquid flow rate, the flowmeter (4) model (Dwyer-VFC-121-EC-5" Scale) is used, Also for determination of the temperatures in this experiment, the temperature indicator (13) model (Emko-ESM 4430) (48x48mm) is used to detect the measuring value of temperature, the temperature of the exhaust air is measured by using a thermocouple

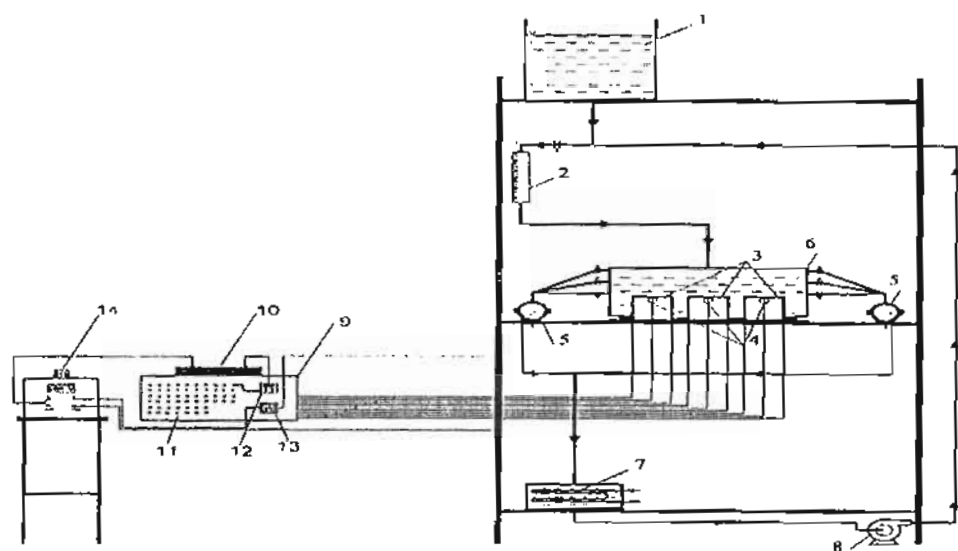

1-Feedback tank.	6-Cooling chamber.	11- Thermocouples.
2-Flow meter (rotometer).	7-Heat exchanger.	12-Temperature indicator.
3-Chips.	8- Pump.	13- Ammeter.
4-Heaters.	9- Control panel.	14- Voltage transformer (Variec).
5-Headers.	10- AC electric source.	

Fig. (1) Schematic diagram of the experimental test rig

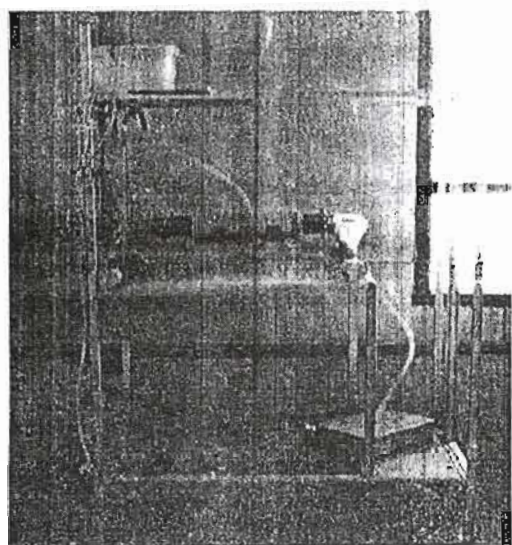

Fig. (2) Photograph of the experimental test rig

EXPERIMENTAL PROCEDURE AND ANALYSIS

The electric power to chips is turned on till the chips temperature reached steady state. Then, valves is turned on to allow the flow passes through the test section . Experimental results were taken every five minutes till the chip temperature reached to steady state.

The following data were calculated from the experimental data

1-The rate of heat generated through the electric resistance of the heater is equal to the heat transfer to the flowing air and is calculated by:

$$Q = IV \cos \phi \quad (1)$$

- 2- The mean velocity u of liquid cooling from the vortex tube is given by:

$$u = \dot{V}_o / A_c \quad (2)$$

- 3- The average wall temperature of the tested body is defined as:

$$T_{w,avg} = \frac{\sum_{i=1}^n T_{w_i}}{n} \quad (3)$$

- 4- The Reynolds number, Re is defined as:

$$Re = \frac{C_o H_o}{\nu} \quad (4)$$

- 5- The average heat transfer coefficient for the inside cabinet is given by:

$$h = \frac{Q_u}{A_s (T_{w,avg} - T_b)} \quad (5)$$

Where:

Q_u useful heat, $= Q - Q_{loss}$

Q_{surr} surrounding heat, $h_o A_s (T_o - T_s)$

T_b bulk air temperature, $(T_i + T_o)/2$.

A_s surface area of the chip.

- 6- The average Nusselt number is given by:

$$Nu = \frac{h L}{\lambda_o} \quad (6)$$

PHYSICAL PROBLEM

The physical model, that describes the case of study, the geometry and boundary conditions are shown in Fig. (3), the flow is approximated to be two-dimensional flow in the x-y plan.

PROBLEM DESCRIPTION

A cooling chamber side view is shown in Fig. (3), the blocks are a simulation of the chips. Its length is 100 mm and 40mm width. The heat flux of is the chips body is W/cm^2 . The inlet liquid cooling port in the

middle of the top, and a longitudinal opening also representing also the outlet port is located in different places.

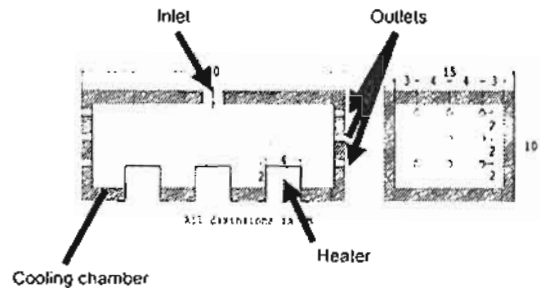

Fig. (3) Problem Description and boundary conditions

NUMERICAL SOLUTION

The two-dimensional steady-state, turbulent compressible flow in the cabinet is governed by continuity, momentum and energy equations together with applying the turbulence $k-\epsilon$ model.

After setting the governing equations, a numerical method is used to convert it into a set of algebraic equations. Then, the computational fluid dynamics "Fluent 6.3.26" based on the SIMPLE technique, Patanker [18], is introduced to simulate the problem under consideration.

THEORETICAL MODEL

Continuity equation

$$\frac{\partial(\rho u)}{\partial x} + \frac{\partial(\rho v)}{\partial y} = 0 \quad (7)$$

Momentum equations:

$$\rho \left(u \frac{\partial u}{\partial x} + v \frac{\partial u}{\partial y} \right) = - \frac{\partial P}{\partial x} + \mu \nabla^2 u - \rho \left(\frac{\partial \overline{u'^2}}{\partial x} + \frac{\partial \overline{u'v'}}{\partial y} \right) \quad (8)$$

$$\rho \left(u \frac{\partial v}{\partial x} + v \frac{\partial v}{\partial y} \right) = - \frac{\partial p}{\partial y} + \mu \nabla^2 v - \rho \left(\frac{\partial u'v'}{\partial x} + \frac{\partial v'^2}{\partial y} \right) \quad (9)$$

Energy equation:

$$u \frac{\partial T}{\partial x} + v \frac{\partial T}{\partial y} = \left(\alpha + \frac{u_t}{\sigma_t} \right) \nabla^2 T + \mu \phi + S_T \quad (10)$$

Turbulence energy equation:

$$u \frac{\partial k}{\partial x} + v \frac{\partial k}{\partial y} = \left(\nu + \frac{u_t}{\sigma_k} \right) \left(\frac{\partial^2 k}{\partial x^2} + \frac{\partial^2 k}{\partial y^2} \right) + (u + u_t) G C_1 \varepsilon - \beta g \frac{u_t}{\sigma_k} \frac{\partial T}{\partial y} - \varepsilon \quad (11)$$

Turbulence dissipation rate equation:

$$u \frac{\partial \varepsilon}{\partial x} + v \frac{\partial \varepsilon}{\partial y} = \left(\nu + \frac{u_t}{\sigma_\varepsilon} \right) \left(\frac{\partial^2 \varepsilon}{\partial x^2} + \frac{\partial^2 \varepsilon}{\partial y^2} \right) - \left(C_1 \beta g \varepsilon \frac{u_t}{\sigma_k} \frac{\partial T}{\partial y} - C_2 \varepsilon^2 \right) / k + \left(\nu + \frac{u_t}{\sigma_\varepsilon} \right) C_1 \varepsilon G \quad (12)$$

Where:

$$G = 2 \left[\left(\frac{\partial u}{\partial x} \right)^2 + \left(\frac{\partial v}{\partial y} \right)^2 \right] + \left(\frac{\partial u}{\partial y} + \frac{\partial v}{\partial x} \right)^2 \quad (13)$$

The turbulent kinematic viscosity is:

$$\nu_t = C_\mu \frac{k^2}{\varepsilon} \quad (14)$$

where:

The turbulence dissipation rate is given by:

$$\varepsilon = C_D \frac{k^2}{\ell} \quad (15)$$

The k-ε model constants C_μ , C_1 , C_2 , σ_k , σ_ε and σ_ε values are presented in table (1).

Table (1): The standard values of k-ε model constants [18].

C_μ	C_1	C_2	σ_k	σ_ε
0.09	1.44	1.92	1	0.9

Boundary Conditions

The boundary conditions along the domain for all dependent variables are shown in Table (2).

Table 2 Boundary condition

Boundary	Location (mm)	Variable							
		Heat Flux (W/cm ²)				Velocity, m/s			
		Case (a)	Case (b)	Case (c)	Case (d)	Case (e)	Case (f)	Case (g)	Case (h)
Inlet flow	132.7 x 7.144 y = 76	0	0	0	0	0.2445	0.2073	0.23	0.26
Chip	187 x 7.78 1187 x 7.158 198.7 x 7.238 87 y 7.20	0.52	1.04	1.56	2.08	0	0	0	0
walls	Right Wall x = 276 87 y 7.76	0	0	0	0	0	0	0	0
	Left Wall x = 0 87 y 7.76	0	0	0	0	0	0	0	0
	Bottom wall y = 0 0.7 x 7.276	0	0	0	0	0	0	0	0
	Top wall y = 76 0.7 x 7.276	0	0	0	0	0	0	0	0
Outlet flow	X = 0 9.7 y 7.67 x = 276 9.7 y 7.21 32.7 y 7.44 55.7 y 7.67	set	set	set	set	set	set	set	set

RESULTS AND DISCUSSION

The results consists of theoretical and experimental results

Theoretical Results

The present numerical model is used for case of forced convection flow from three generating heat sources. The numerical model for the analysis of quite accurate and cost efficient compared to the experimental approach. Numerical simulation allows obtaining results faster than experimental when a hardware change is necessary. The theoretical results of the system used are obtained at different conditions for water and transformer oil. It will explained in the following results.

Theoretical results fo water

Effect of outlet ports at different flow rate

In this analysis the flow enters from the upper level and exit from the different sides levels (down level, middle level and upper level).

First outlet port (Down level), $q1 = 0.52$ W/cm², $V1 = 0.2445$ m/s

Figure (4) shows the variation of the streamline and temperature along the block of heat source surfaces. As shown from Figure (4-a) recirculation zones are found at the sides above the exit section. As shown from Figure (4-b) the chip 2 is lower temperature as chip 1 and 3 for the upper surface but in the other hand the side's surface of chip 2 is the higher value than the other two chips.

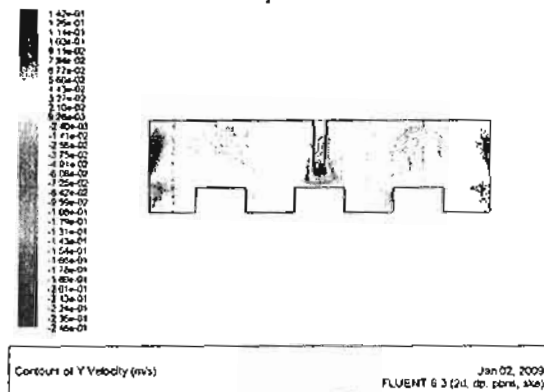

Fig. (4-a): variation of the streamlines at flow exit from the lower exit suction

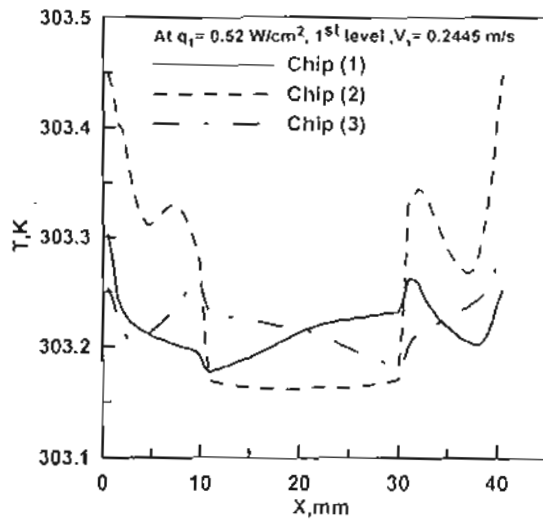

Fig. (4-b): Surface temperature variation along the heaters at flow exit from the lower port

Second outlet port (Middle level) At $q_1 = 0.52 \text{ W/cm}^2, V_1 = 0.2445 \text{ m/s}$.

Figure (5) shows the variation of the streamline and temperature a long the

block of heat source surfaces. As shown from Figure (5-a) recirculating zones are found at different section. As shown from Figure (5-b) the chip 2 is lower temperature as chip 1 and 3 for the upper surface but in the other hand the side's surface of chip 2 is the higher value than the other two chips.

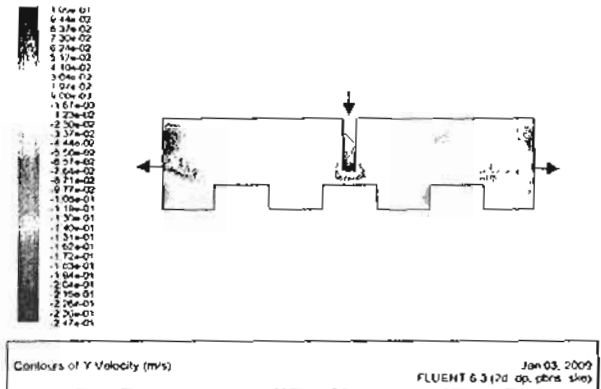

Fig. (5-a): variation of the streamlines at flow exit from the middle exit

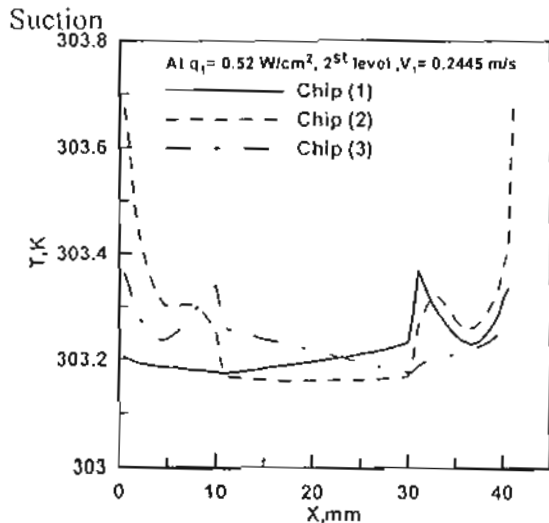

Fig. (5-b): Surface temperature variation along the heaters at flow exit from the middle port

Third outlet port (Up level) At $q_1 = 0.52 \text{ W/cm}^2, V_1 = 0.2445 \text{ m/s}$

Figure (6) shows the variation of the streamline and temperature along the block of heat source surfaces for flow exit from the upper port. As shown from Figure (6-a) recirculating zones are

found at different section and beside the heaters 1 and 3. As shown from Figure (6-b) the chip 2 is lower temperature as chip 1 and 3 for the upper surface,

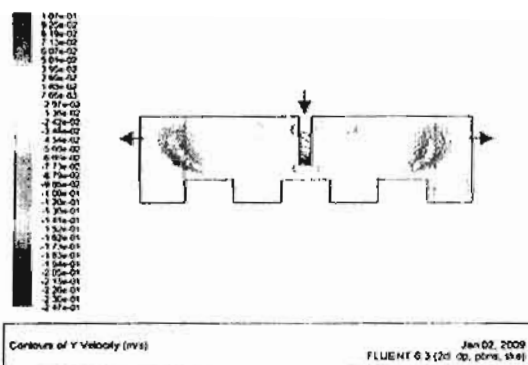

Fig. (6-a): variation of the streamlines at flow exit from the upper port

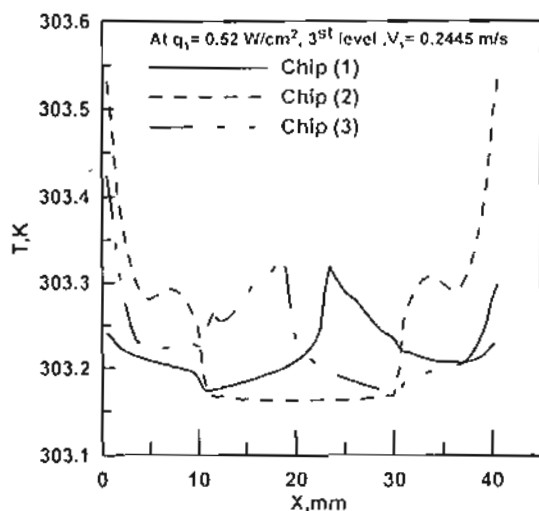

Fig. (6-b): Surface temperature variation along the heaters at flow exit from the upper port

As shown from the previous analysis for the flow exit from the three different sections at $q_1 = 0.52 \text{ W/cm}^2$, $V_1 = 0.2445 \text{ m/s}$. It can be concluded that the best cases when the flow exit from the lower port. To support this conclusion, the results were obtained at different exit air velocity for the flow exit at different suction. All

results were shown that the best condition at the flow exit from the lower port.

Variation of chip average temperature with Reynolds number

Fig. 7 shows the variation of average temperatures of the three chips used with Reynolds when using water as a fluid. It can be observed that the increasing of Reynolds number decrease the average temperature. This is due to increasing the heat transfer coefficient at a higher value of Reynolds number. It can be seen that the chips temperature decreases with Reynolds number increases. This is due to higher heat transfer coefficient at a higher values of Reynolds number.

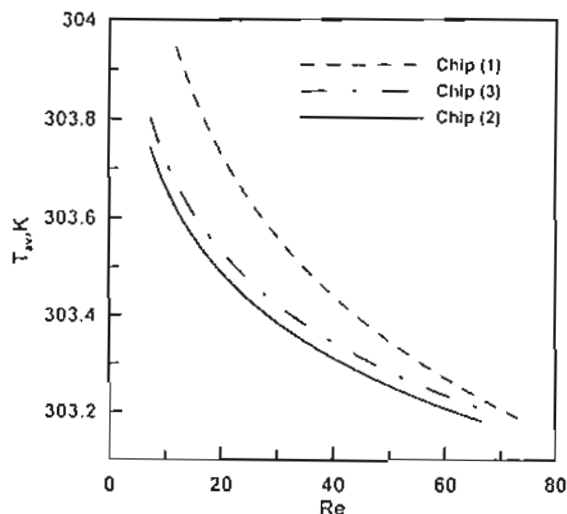

Fig. 7: Variation of average temperatures of the three chips used with Reynolds

Experimental results of water

The experimental data obtained for water and transformer oil at different conditions were presented in the following analysis. The experimental were carried out at the flow exit at four different levels. The first level flow rate equals 0.5 l/min , at second levels flow rate equals 1.5 l/min , at third levels flow rate equals 2 l/min and at fourth level flow rate equals 2.5 l/min

Effect of heat flux at water exit from the first level

Figure 8 shows the variation of the chip temperature for the flow exit from the first level. It can be observed that the chip 2 is lower temperature than other two chips for all values of the heat flux. The average value depends on the heat flux value. Also, it can be observed that steady state reached after about 15 minutes for the three chips.

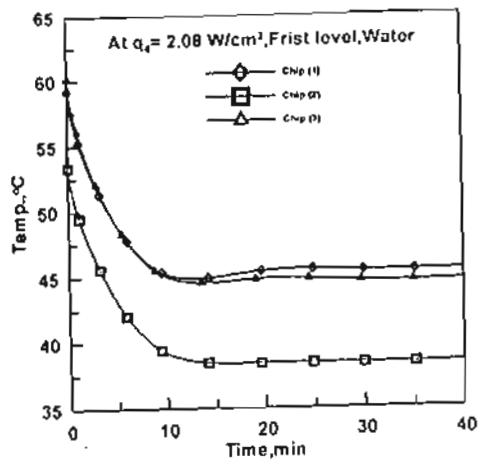

(8-a)

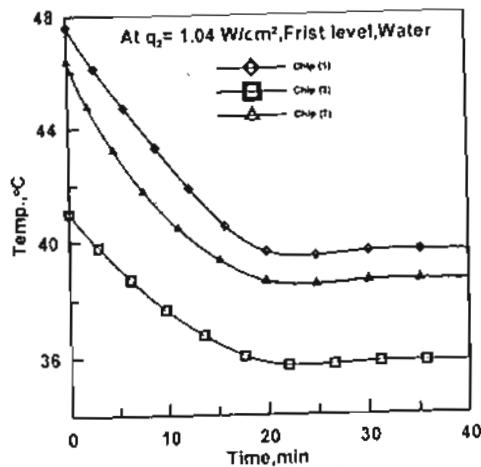

(8-b)

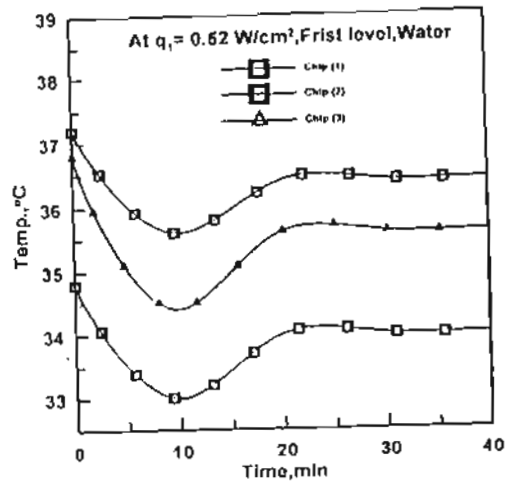
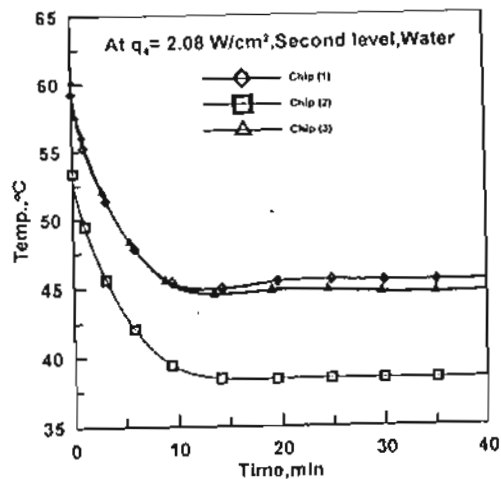

Fig.8: variation of chip temperature for flow exit from the first level at different heat flux

Effect of heat flux at water exit from the second level

The variation of the chips average temperature for the flow exit from the second level at different heat flux is shown in Figure (9). It can be observed that chip 2 is lower temperature than chip 1 and 3. Also, it can be seen that steady state condition depends on the heat flux.



(9-a)