

NEW PARAMETERS FOR ASSESSEMENT OF MATURITY OF COTTON FIBRES

Dr. A.M.El-Hadidy

Textile Eng. Dept., Faculty of Engineering, Mansoura Univeristy.

الخلاصه: يقترح هذا البحث تقدير نضوجه الشعيرات القطنيه من خلال تعيين متوسط نسبة امتصاص وزن ثابت من شعيرات القطن لمحلول من الصودا الكاويه تركيز 18% وتعيين معامل انضغاط نفس الوزن السابق ، واخيرا عدد الالتواءات في طول 1 مم من الشعيرات القطنية .

في الطريقة الاولى عين متوسط نسبة الامتصاص على النحو التالي : غمر 1 جم من شعيرات القطن لمدة 15 دقيقة في محلول الصودا الكاويه تركيز 18% ثم عصرها تحت ضغط مقداره 4 جم لمدة خمس دقائق ثم وزنت العينه وتم حساب متوسط نسبة الامتصاص ، في حين استخدم جهاز شيرلي لقياس السمك في قياس وتعيين معامل انضغاط 1 جم من الشعيرات . اما لتعيين عدد الالتواءات فقد تم استخدام الميكروسكوب الضوئى العادى في حصر عدد الالتواءات في طول مقداره 1 مم من الشعيرات المراد اختبارها .

وقد ثبت أنه بالنسبة للشعيرات الناضجه يزداد كل من متوسط نسبة الامتصاص ، وعدد الالتواءات بينما يقل معامل الانضغاط والعكس صحيح بالنسبه للشعيرات الغير ناضجه . تم احصائيا حساب عدد العينات التى تعطى معامل دقه قياس يساوى $\pm 2\%$ في كل طريقه من الطرق الثلاث .

ABSTRACT- The maturity of cotton fibres could be assessed by making use of three new parameters namely mean per cent of absorbed NaOH(18%), cotton fibre compression modulus, and convolution frequency. These three parameters are obtained when a constant weight of loose cotton fibre is immersed in 18% NaOH solution for 15 min. at room temperature and squeezed under a load of 4 Kg for 5 minutes, then weighted. The compression modulus is obtained when the same sample is subjected to compression, while the convolution frequency was measured by optical microscopic method. It was found that fibres which are considered mature show high absorbtion for NaOH, low compresstion modulus and of high convolution frequency. The opposite holds good for cottons of low maturity.

1. INTRODUCTION:

Maturity of cotton fibre is a determining factor in the overall quality of cotton. No commercial cotton has ever been found to be 100% mature. However, in common practice, a normal cotton with a maturity of 70% is processed efficiently and produces yarns of acceptable quality. When maturity falls as low as 50% - 60% range, processing difficulties result, as indicated by increased ends down in spinning, and decreased product quality /1/.

A number of techniques have been developed for the determination of maturity of cotton fibres. In one of them, individual cotton fibres swollen with desolved water on a glass slide and examined under a microscope. These swollen fibres are classified into eleven groups as shown in Fig.(1) /2/, or classified into three groups mature, half mature, and immature according to /3/, or classified into two groups as in /4/.

Another optical method is based on the birefringence property of cotton fibres (ASTM Designation D- 1449) /5/. A differential dyeing technique has been developed by Goldthwit et al./6/ to estimate maturity. The resistance offered to air flow by a plug of cotton fibres has been found to be dependent not only on the fineness but also on the maturity of the fibres. This principle was first employed in the design of the Arealometer /7/, which has been used to estimate the maturity ratio. Using Micronair tester the difference in Micronair readings with and without mercerization of cotton fibres has been found to be related to the maturity of the fibre sample (ASTM: D 2480 - 67)/8/.

A number of techniques based on centrifugation after soaking the fibres in different swelling and nonswelling agents have been used for the determination of fibre maturity /9/.

It is thus seen that all these methods are tedious, subjective, have rather limited accuracy, or required large samples.

It was, therefore, felt that there is still a need for developing a simple, fast, and reproducible method for determining the maturity of cotton fibre.

2. EXPERIMENTAL DETAILS:

2.1. Materials:

Cotton belonging to different species and having a wide range of maturity were selected for the study. The cotton varieties examined here are Egyptian cotton that are widely used in the textile industry in Egypt. These cottons are (Giza 45, Giza 75, Giza 74, and Dandra). In addition to this some Sudanese cottons namely (Gezira 1, Gezira 2, Barakat 1, Barakat 2, Nuba, 3H, 2 SG, 4 VS and 1 ICG), were used for the purpose of comparison. Also Russian (Tushkand -1), and American (Upland) varieties were also used in the present investigation. The cottons fibres were examined in their raw state.

2.2 Test Method:

The per cent maturity values (M) were determined by the sodium hydroxide method (ASTM: D 1442 - 75 I). The tensile strength at breaking extension (P.I.) was determined with Presly tester at 0-inch. The mean per cent of absorbed NaOH of cotton sample was measured if the individual readings taken with torsion balance of 0.1 mg accuracy.

In this method cotton fibres of 1 g, are immersed in 18% NaOH solution for 15 min. at room temperature then left hanging for 3 min., compressed between two glass plates under 4 Kg for 5 min., and then weighted. The percentage increase in weight of the sample is then determined.

The mean percentage of absorbed NaOH by 1 g of loose cotton fibre could be determined from the equation

$$\bar{A} = \frac{W_w - W_R}{W_R} \times 100\% \quad \dots\dots(1)$$

where; W_w = sample weight after treatment
 W_R = sample weight before treatment.

The compression modulus (C.M.) was measured at twelve pressure ranging between 0.2 and 104.2 (g/cm²) using the Shirley Thickness Gauge with the largest foot (Area = 50 cm²) and fibre attachment as shown in Fig.2-a and 2-b.

The compression modulus could be determined according to the equation:

$$C.M. = \frac{t_1 (P_2 - P_1)}{t_1 - t_2} \quad \dots\dots(2)$$

where; t_1 and t_2 are loose cotton fibre thickness measured at two arbitrarily pressure P_2 and P_1 respectively.

In the present investigation the (C.M.) was determined from thickness-pressure curve at the region falls between pressures 64.2 and 104.2 g/cm², which showed a variation in compression modulus. (See Fig. 3)

While convolution frequency can be measured by optical microscopic method as shown in Fig. 4. In preparing test specimens for examination under the microscope, the method described in ASTM Designation D 276 - 62 I was used /10/.

3. RESULTS AND DISCUSSION:

3.1 Determination of the Required Number of Samples For Testing:

To determine the suitable number of samples required for testing, a trial has been made first using three cotton samples with 1g weight, then the mean per cent of NaOH absorbed/compression modulus was measured and analyzed statistically. The procedure of this determination is given in Ref./11/.

Given in Table I are the values of mean absorption per cent of NaOH (18%) by cotton fibres.

Type of Cotton	1	2	3	\bar{X} (%)	σ (%)	cv (%)	P (%)
4VS	3.964	3.959	4.015	3.978	0.031	0.8	± 1.9

For 4VS the relative error (P) was found to be $\pm 1.9\%$. This per cent is less than that given by CSN 800301 standards ($\pm 2\%$). This means that the number of tested sample is enough.

Given in Table II are the values of thickness - pressure of different samples for Up-land (American cotton fibre).

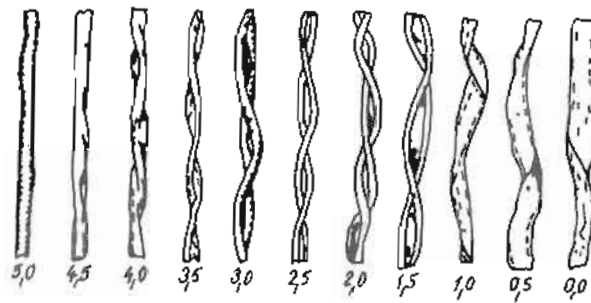

Fig.1. Shows cotton fibres are classified according to its degree of maturity to 11 divisions after its immersion in distilled water and microscopic examination.

Fibre 5,0 corresponds to mature.

Fibre 0,0 corresponds to immature /2/.

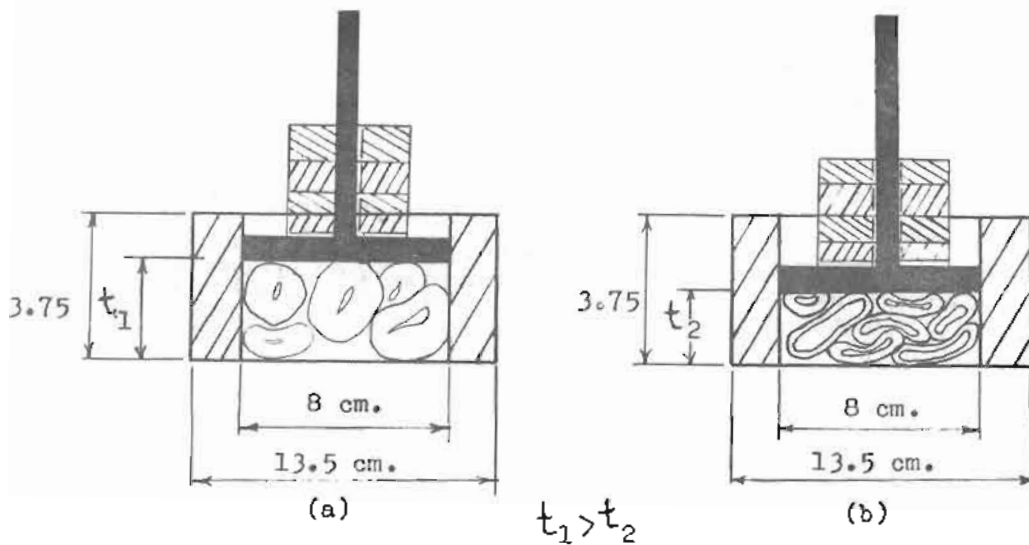

Fig.2. Schematic drawing of compression chamber in Shirley Thickness Gauge.

a) In case of mature cotton fibres.

b) In case of immature cotton fibres.

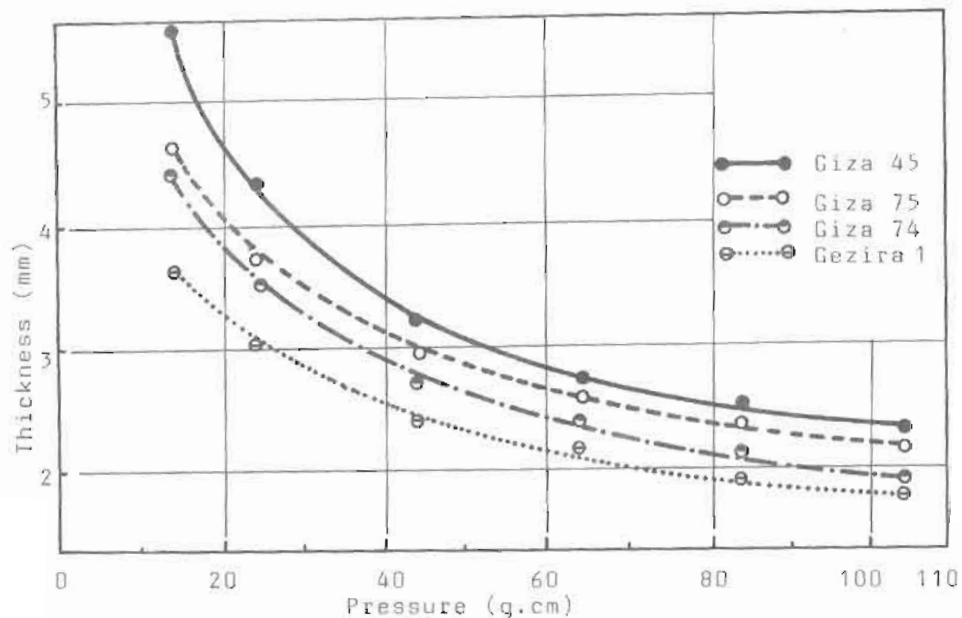

Fig.3. Fibre mass thickness versus pressure.

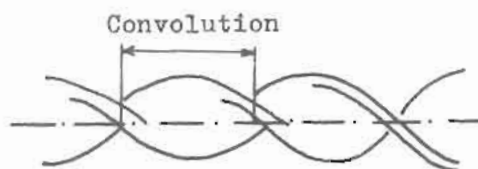

Fig.4. Schematic diagram showing convolutions.

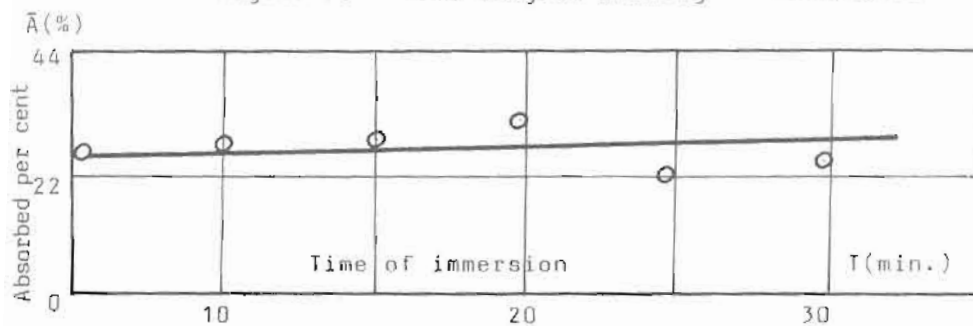

Fig.5. NaOH absorption percent versus time of immersion.

Table(II)

Pressure (g.cm ⁻²)	Samples				\bar{x} (mm)	σ (mm)	C.V. (%)
	1	2	3	4			
14.2	4.20	5.00	4.60	4.50	4.575	0.330	7.20
24.2	3.47	3.80	3.59	3.50	3.590	0.149	4.15
44.2	2.80	2.90	2.85	2.68	2.810	0.094	3.36
64.2	2.50	2.50	2.50	2.31	2.450	0.095	3.87
84.2	2.25	2.29	2.28	2.10	2.230	0.088	3.96
104.2	2.10	2.10	2.10	2.00	2.075	0.050	2.41

For Up-land the relative error (P) was found to be $\pm 3.8\%$. This per cent is higher than that given in the CSN 800301 standards ($\pm 2\%$). This means that the number of tested samples are not enough and should be increased. The correct number of cotton samples, required for such relative error ($\pm 2\%$) in number of samples, was obtained from the statistical charts of CSN 800301 /12/. This number was found to be 5. Accordingly this number of sample was used throughout the whole tests.

3.2 Results of Mean Per Cent Absorption of NaOH;(18%).

The secondary wall of a mature fibre is practically pure cellulose and probably represents about 90% of the fibre weight /13/. In general thick-walled fibres absorbed NaOH more than thin-walled fibres during immersion process, and then mean per cent of absorbency of NaOH can be used as a maturity measurement.

In the present study on a Gizera 2 Sudanese cottons six replicate measurements gave a mean per cent absorption of NaOH of 22.3% with a standard deviation of 0.284%, a coefficient of variation of 1.269%, and a relative error of 1.7%. The effect of time of immersion in alkali and mean per cent of absorption (\bar{A}) is shown in Fig.(5).

It is seen that maximum absorption takes place in about 20 min. but immersion time of 15 min. is quite sufficient to give less C.V.%.

Figure (6) shows that as the maturity percentage (M) increases, the mean percentage of absorbed alkali (\bar{A}) increases also.

From Fig.(6) it is clear that for raw cotton, a linear relationship of the form

$$M = a + b\bar{A} \quad \dots\dots(3)$$

fits well the observed data. Regression analyses have given the following values for a and b; b = 0.42, and a = 63.5 for raw cotton with a correlation coefficient of + 0.79, and highly significant at the 5% level.

From Table III and according to Spearman's correlation coefficient(R) /14/.

$$R = 1 - \frac{6 \sum d^2}{n(n^2 - 1)} \quad \dots\dots(4)$$

Therefore R_1 (between M and \bar{A}) = 0.867, and
 R_2 (between P.I. and \bar{A}) = 0.879.

There is a close agreement between the ranking of M and \bar{A} , and P.I. and \bar{A} . It is possible to test the significance of the value of R in order to check that the degree of agreement has not arisen purely by chance. The test of significance is made by calculating a value for t and using the t Tables.

$$\text{Then } t = R \sqrt{\frac{n-2}{1-R^2}} \quad \dots\dots(5)$$

t_1 (between M and \bar{A}) = 4.9, and
 t_2 (between P.I. and \bar{A}) = 5.2.

This value of t is compared with the value of t corresponding to n-2 degrees of freedom. The 1 per cent level of t for 8 degrees of freedom is 3.36 and the calculated value of t is 4.9 and 5.2 respectively. One concludes that the degree of agreement between these three parameters, i.e. M, \bar{A} , and P.I., is highly significant.

3.3. Results of Compression Modulus:

Given in Table IV are the values of fibre maturity (M), compression modulus (C.M.), and fibre bundle strength (P.I.). It was found that the ranking correlation coefficient between M and C.M. and between P.I. and C.M. are 0.58 and 0.71 respectively. This indicates that though there is a correlation between these three measurements but not strong as that found between M and \bar{A} (see Fig.7).

3.4. Results of Convolution Frequency:

When a fibre is viewed through a microscope, the most obvious characteristic is its generally flat band structure with corkscrew-like twisting. These twists are designated as convolutions /15/. Convolution generation is intimately related to internal structure and secondary-wall thickness. Very thin-walled cottons generally are lacking in convolutions. It was found, that the convolution frequency varies between 3.414 and 3.244, 3.347 and 2.876, and 2.762 per mm for Giza 45, Giza 75, Barakat 1, Barakat 2, and Up-land cottons respectively.

A linear regression analysis between the microscopically measured convolution frequency and per cent maturity was found in the form of:

$$M = 1.746 \bar{n} + 24$$

Given in Table V, are results of per cent maturity and convolution frequency, which gives a high ranking correlation coefficient (R = 0.943), which is not unexpected since both measurements describe the same character of cotton fibre.

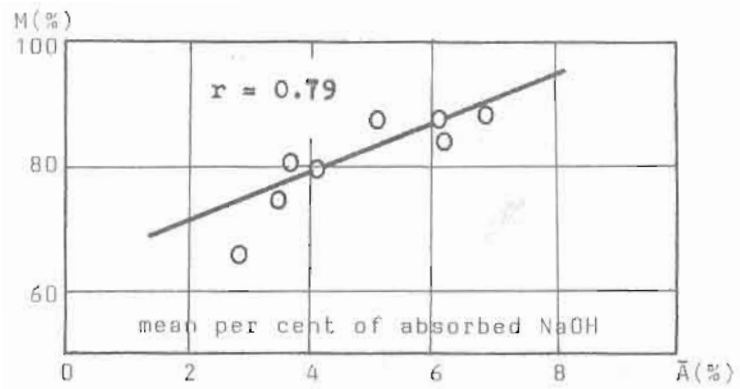

Fig.6. Maturity per cent of "VS" cotton fibres versus mean per cent of absorbed NaOH (18%).

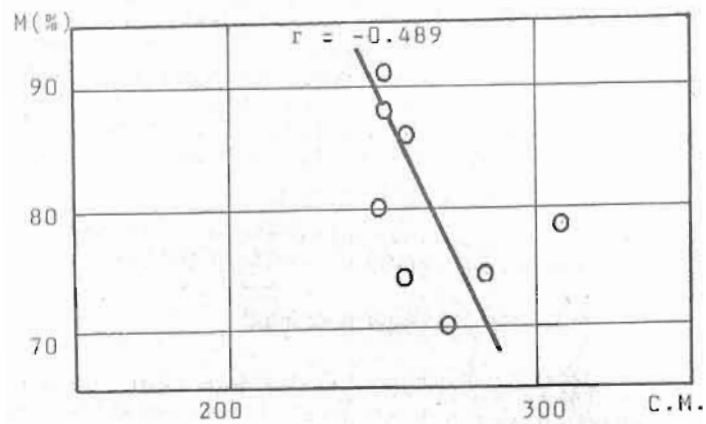

Fig.7. Maturity per cent of "VS" cotton fibres versus compressibility modulus.

Table (III)
Shows the relationship between (M), A, and P.I.

Type of cotton	Maturity percentage M(%)	Average percentage of absorption of N_2O_{10} A(%)	Fibre tensile strength p.i.	Ranking R_1 (between M and A)	Ranking R_2 (between P.I. and A)
Nuba	66	2.9	6.2	1	1
Barakat 1	81	4.1	7.1	2	2
Gezira 1	76	3.5	6.6	1	1
3 H	89	5.1	7.9	4	4
2 SG	82	3.7	6.6	2	2
4 VS	87	3.7	7.8	3	3
Barakat 2	74	3.3	7.4	2	2
Dandra	86	6.3	9.6	3	3
Giza 45	91	6.9	11.0	4	4
Giza 75	89	6.2	10.3	3	3

Table (IV)
Shows the relationship between (M), (C.M.) and P.I.

Type of cotton	Maturity per. M(%)	Compression modulus C.M.	Fibre strength P.I.	Ranking R_1 (between M and C.M.)	Ranking R_2 (between C.M. and P.I.)
Giza 75	89	247.097	10.3	2	2
Giza 74	80	243.903	9.5	1	1
Giza 45	91	247.954	11.0	3	3
Dandra	86	251.572	9.6	2	2
T 1	76	250.250	7.28	1	1
T 1 CG	79	304.321	7.0	3	3
Gezira 1	76	283.849	6.6	1	1
Up-land	72	270.929	7.3	2	2

Ranking R_1 (between M and C.M.) and R_2 (between C.M. and P.I.)
 $d_1^2 = 35$
 $d_2^2 = 24$

Table (V)

Relationship between fibre maturity (M) and convolution frequency (\bar{n}).

Type of cotton	Per cent maturity (M)%	Convolution frequency (\bar{n})
Giza 45	91	3.414
Giza 75	89	3.244
Gizera 1	76	3.185
Barakat 1	81	3.347
Barakat 2	74	2.876
Up-land	72	2.762

3.5. Limitation of These Methods:

The mechanical damage that occurs during ginning processing of cotton, stored periods, microbial damage, and the presence of any other type of damage, are responsible for the considerable change in both tested value of mean per cent of absorbed NaOH and compression modulus. In order to detect the presence of any damage, two different procedures can be followed:-

- 1) The per cent maturity (M) can be determined by sodium hydroxide method as a check,
- 2) Alternatively, convolutions frequency method can be obtained as a last check.

To obtain the best result from compression modulus method, we need high pressure to compress single loose cotton fibres, i.e. large pressure than 104.2 g/cm². Pressure like that, which we need will give a straight line in thickness - pressure relationship, and caused difficulties in calculation of the compression modulus.

4. CONCLUSIONS:

The mean per cent of absorbed alkali test thus appears to be a convenient and highly reproducible method for determining the maturity of cotton fibre. It was found that fibres which are considered mature show high absorption for NaOH and of low compression modulus and of high convolution frequency, if no damage is present in the fibre.

A linear relationship has been found between mean per cent absorption NaOH by tested cotton sample and its maturity per cent. The mean per cent absorption NaOH is highly correlated with fibre maturity than compression modulus.

The method of determining the maturity of cotton fibres as a function of mean per cent absorption method is easier than that with compression modulus method.

A positive relationship has been found also between cotton per cent maturity and convolution frequency.

Convolution frequency method can be used as the best method for determining cotton fibre maturity but it needs large number of tested fibres (not less than 2000 fibre according to (CSN 800301).

LITERATURE CITED

- /1/ Rollins, M.L.: Fine structure of cotton fibres, New York, 1973.
- /2/ Jankovsky, J. a Pechacek, F.: Zkouseni textilií, S N T L, Praha, S. 155, 1980.
- /3/ British Standard, Handbook, No.(11) 1956, P. 53.
- /4/ ASTM D-1442 - 75 Maturity of cotton fibres (Sodium hydroxide swelling and polarized light procedures).
- /5/ ASTM D-1449: Test for specific area and immaturity ratio of cotton fibres.
- /6/ Goldthwait, C.I., Smith,H.O., and Barnett, M.P., New Dyeing Technique Shows Maturity of Cotton, Textile World 97, 105-108, 1947.
- /7/ Hetel, K.L. and Craven, C.J.: Cotton Fineness and Immaturity as Measured by the Arealometer, Tex. Res. J. 21, 765-774, 1951.
- /8/ ASTM D-2480 - 67: Test for maturity index and linear density of cotton fibres by the causticaire method.
- /9/ Venkatesh, G.M., and Dweltz, N.E.: A New Method for Determining Maturity of Cotton Fibres, Tex. Res. J. 3, 230-235, 1975.
- /10/ ASIM D: 276 - 26 T. Identification of fibres in textiles.
- /11/ El-Hadidy, A.M. et.: Geometrical and Dimensional Properties of cotton Treated with Zinc Chloride Swelling Agent, CCT, nr. 3, 1988 (to be published).
- /12/ CSN 800301. (Czech, Standards for Determination of sample size in Textile Fields).
- /13/ Maucrsberger, H.R.: Textile Fibres, New York, P. 234, 1947.
- /14/ Booth, J.E.: Principles of textile testing, London, P. 73-74, 1968.
- /15/ Berkley, E.E.: Textile Res. Journal, 18, 71, 1948.