



Experimental Study of Sand-Water Flow in a Circular Duct

دراسة عملية لسريان الرمل والماء في أنبوبة ذات مقطع دائري

Mohamed H. Mansour, Mohamed M. Shamekh, Lotfy H. Rabie

KEYWORDS:

Slurry flow, sand concentration, sand diameter, pressure drop, friction factor.

المخلص العربي: نظرًا للتطبيقات الهائلة للسريان ثنائي الطور في الحياة العملية والمجالات الهندسية فقد ازدادت أهمية دراسته. لذا في هذا البحث تم دراسة سريان خليط من الرمل والماء داخل خط أنابيب مغلق وذلك بهدف دراسة مفاهيم الضغط ومعامل الاحتكاك في حالة السريان ثنائي الطور. تمت دراسة تأثير تغيير كل من قطر الرمل المستخدم والنسب الحجمية للرمل في الماء على مفاهيم الضغط ومعامل الاحتكاك للسريان ثنائي الطور. تم عمل الخليط باستخدام ثلاثة أقطار للرمل (0.15 و 0.3 و 0.44 مم) ولكل قطر من هذه الأقطار، تم تكوين الخليط بثلاث نسب حجمية (2.5% و 5% و 10%). هذا النموذج العملي كان قادرًا على التنبؤ بالمفاهيم نتيجة الاحتكاك وحساب معامل الاحتكاك. النتائج العملية أظهرت أن الفقد في الضغط نتيجة الاحتكاك وبالتالي معامل الاحتكاك يزداد بزيادة رقم رينولدز وزيادة قطر الرمل وزيادة تركيزه الحجمي في الخليط.

Abstract— Due to the huge applications of the sand-water slurries in nature and industry, the importance to study the sand-water flow increased. In this paper, the turbulent flow of sand-water slurries is experimentally studied in a closed-loop pipeline system in the laboratory. The experiments are utilized to show the effect of the variation of both the sand diameter and the sand concentration on the two-phase pressure drop and the two-phase friction factor by changing the Reynolds number and the sand volume concentration. The pressure drop is increased along with the Reynolds number.

In the experiments, three different sand diameters are used at different three concentrations with water. The diameters of the sand are 0.15, 0.3 and 0.44 mm, while the concentrations of the sand are 2.5%, 5% and 10%. The experiments show that the pressure drop and the friction factor are increased with increasing the sand diameter and the sand volume concentration.

Received: 15 March, 2018 - Revised: 28 June, 2018 - Accepted: 18 July, 2018

Mohamed H. Mansour is with Mechanical Power Engineering Department, Faculty of Engineering, Mansoura University, El-Mansoura 35516, Egypt (e-mail: mhsaadany@mans.edu.eg).

Mohamed M. Shamekh is with The Egyptian Natural Gas Company GASCO (e-mail: mohamed_shamekh@gasco.com.eg).

Lotfy H. Rabie is with Mechanical Power Engineering Department, Faculty of Engineering, Mansoura University, El-Mansoura 35516, Egypt (e-mail: lotfyrs@hotmail.com).

Furthermore, the pressure drop is increased for high mixture flow rates.

I. INTRODUCTION

WATER-Sand flows occur in many engineering applications such as; drilling of oil wells, ground water, concrete, ceramics and other mining operations. There are also some situations arising in nature which involve water-sand flow, which arises from the rain in the high desert areas, moving to low places.

Most of the earlier studies were done at relatively low concentrations due to its applications in the industry. Wasp et al. [1] studied the properties of the sand-water mixture flow in pipelines. They concluded that the nature of flow (i.e., laminar, transition, and turbulent) depends on the properties of the mixture and the pipeline roughness. It was found also that the sand-water mixture flow is difficult to compare with the homogeneous water flow mainly for two causes. The first one is that, the sand particles change the properties of the sand-water mixture. The second cause is depending on the conditions of the sand particles to have range of sand-water mixture behaviors. Micale et al. [2] studied numerically the water-sand mixture flow. They simulated the solids suspension of 9.6% and 20% volume fractions using the Multi

Fluid Model approach and sliding grid (SG) approach using the Schiller Nauman drag model. Satisfactory results at low speeds were obtained.

Kaushal and Tomita [3] studied the concentration and distributions of sand in water-sand mixture flow through pipeline by using γ -ray. Their results showed that the pressure drop profiles of water-sand flow looks like that of pure water for finer sand particles at low sand concentrations. In this case, particles were absent beside the pipeline wall and were in suspension state. Otherwise for sand concentration value of 50% and coarser sand particles, the pressure drop had skewed profiles of equivalent water-sand flow. The coarser particles were existed beside the pipeline wall due to the effect of viscous turbulent on the bottom particles which increases the interactions between particles.

Kim et al. [4] studied the flow of sand-water mixtures through square ducts, focusing on the economic transport of sand particles. The measured data of the hydraulic gradient, solid effect, and deposition limit velocity for square duct were compared with that of corresponding to the sand-water flow through circular pipe. The hydraulic gradient of pure water through the circular pipe was found larger than the hydraulic gradient in the square duct because of the secondary flow in the square duct. Opposite results were obtained in the case of sand-water mixture flow. It was found that the hydraulic gradient of the mixture flow in the circular and square pipelines is directly proportion with the solid concentration and Reynolds number.

Ochieng and Onyango [5] used many drag correlations to study the sand-water flow characteristics. They validated their results against the experimental one at volume fractions varying between 1% and 20%. They discussed the blending process to follow the transient concentration variations of a tracer that had been released as appoint source in the flow. The mixing time was calculated from the concentration variations at a single point in the flow, and compared to the experimental measurement. The measured mixing times and those predicted by literature correlations agreed with each other by 90%.

Furthermore, Kasat et al. [6] used the Eulerian model for a 10% sand concentration. In particular, they studied the water-sand mixture and the formation of a solid free layer on the top of a tank.

Tamburini et al. [7] studied different modification methods of the drag function and compared their results with the measurements of Micheletti et al. [8]. Their velocity profiles were not compared to any other experimental results. Kaushal et al. [9] studied numerically the motion of shaving fine particles at higher solid concentrations up to 50% (namely, 0%, 30%, 40% and 50%) in pipelines using the CFD. They investigated the flow characteristics using the mixture and Eulerian two-phase models separately. They recommended using the Eulerian model for these flows as the model predicted the pressure drop and the solid concentration profiles quite accurately for all tested cases.

Faraj et al. [10] showed a comparison between the Electrical Resistance Tomography system (ERT) in surveying the sand distributions in horizontal and vertical directions of the mixture of the sand-water with the actual photographs of

the sand-water mixture flow. The results of ERT showed good agreement with the other results. So, the ERT system could well be used for surveying the distributions of the solid through pipelines.

Nabil et al. [11] obtained numerically the solution of sand-water slurry flow to have better insight about the complexity of slurry flow in pipelines using three different sand particle sizes (0.2, 0.7 and 1.4 mm) at different concentrations (from 5% to 30% by volume). In order to evaluate the applicability of this model, it has been compared with their and previous experimental data. They obtained a satisfactory agreement between the calculated results and the experimental data especially for fine slurries.

Eltoukhy [12] investigated the effect of solid concentrations and inclination angle of the pipeline on the sand-water mixture flow hydraulic gradient. The values of the angle of the pipe inclination of 5, 10, 25, 35, and 45° upward and downward positions, in addition to the horizontal and vertical positions were studied. Three values for the concentration of solid in the sand-water mixture of 5, 10, and 15% by volume were used for each inclination position. It was found that the values sand-water mixture flow hydraulic gradients through the pipeline laid upward sloping position are always greater than the corresponding values of each horizontal and downward pipeline positions for any value of the concentration of solid and inclination angle. The hydraulic gradient through the pipeline was directly proportion with the concentration of the solid.

Kumar et al. [13] investigated the effect of particle size on the various flow parameters of sand-water slurry through 53.2 mm pipe diameter horizontal pipe for a mixture velocity range of 1.8–3.1 m/s and an overall sand volumetric concentration range of 15–45% with four grain sizes (0.18, 0.3, 0.44 and 2.4 mm). The simulated local solid concentration values were found to be in good agreement with the experimental results of the solid concentrations and the velocities for smaller grain sizes viz. 0.18 and 0.3 mm. Deviations between these values were recorded in the lower half of the cross-section just near the wall for bigger grain sizes (0.44 and 2.4 mm only). The pressure drop was increased with increasing the volumetric concentration for all grain sizes. Also, at any particular volumetric concentration, the pressure drop was increased with increasing the grain size. This increase was approximately 3 to 6 times when the grain size increased from 0.18 mm to 2.4 mm.

Parkash [14] numerically simulated slurry flow consisting of water plus sand through a horizontal pipe. The sand particles having 125 μm mean diameter in water was analyzed through 54.9 mm diameter pipe at volume concentrations ranging from (10-20%) by weight for the flow velocity of 3 m/s. Eulerian model with the RNG k - ϵ turbulence closure was adopted to analyze the slurry flow. The results of the slurry flow in terms of concentration and velocity profiles were predicted.

In the present study, the investigation of the two-phase (sand-water) pressure drop is presented. The effect of the sand concentration variation ($C = 2.5\%$, 5% and 10%) and diameter variation ($d = 0.15$, 0.3 and 0.44 mm) on the frictional

pressure drop and the friction factor are studied experimentally.

II. EXPERIMENTAL SETUP

The schematic of the experimental setup is shown in Figure 1. A closed-loop pipeline system consists of a plastic (PVC) mixing tank (3), which has a diameter of 0.60 m and a length of 1.25 m. The tank contains three 45° pitched blades (2) that are connected to an electric motor (1) to make a homogenous mixture of water and sand. Plastic pipes of 0.8" inner diameter and 6 m length are used in the closed-loop. Also, a 1.5 HP pump (7) is used to drive the flow from and to the mixing tank. An orifice meter (6) is installed after the mixing tank to measure the sand-water mixture flow rate. The distance between the orifice and the pump inlet is 0.6 m. Ball and globe valves (4 & 8) are used to control the flow rate value. The pressure drop is measured by installing an inverted U-tube manometer (5) between two horizontal points 3.5 m apart using air as the manometer liquid.

The tests were done for different sand particle sizes and different sand concentrations. Three sand sizes with diameters $d = 0.15$ mm (sand 100), 0.3 mm (sand 50) and 0.44 mm (sand 40) were used.

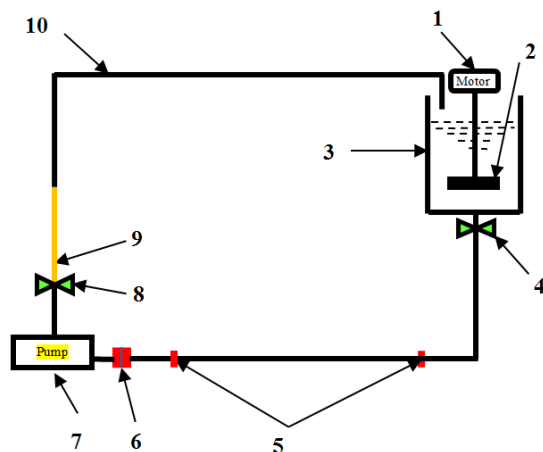

- (1) Electric motor to rotate the mixture.
- (2) Mixing element.
- (3) Mixing PVC tank with a diameter of 0.60 m.
- (4) Ball valve.
- (5) Pressure difference measured points.
- (6) Orifice meter.
- (7) Pump to circulate the mixture in the closed loop.
- (8) Globe valve.
- (9) Elastic pipe.
- (10) Plastic pipes of $D = 0.8$ ".

Figure 1 Schematic diagram of experimental apparatus.

III. PROCEDURE

The orifice meter is calibrated for all different test cases to calculate the discharge coefficient for each case. The discharge coefficient changes with varying the sand volume concentration in the mixture. Then, different steps are done to measure the pressure drop for the sand-water solution in the test section.

Firstly, sand and water are added to the mixing tank with the required volume percentages until it reaches to a specific level. Secondly, turn on the motor to mix the components, and prepare a homogenous solution. Then, open the globe and ball valves completely and turn on the pump. Now, the mixture flows in a closed loop and the pressure drop between the two points which are 3.5 m apart, are measured using the inverted U-tube manometer. Finally, close the globe valve slightly and measure the pressure drop for different flow rate values. Change the sand concentration and repeat the past steps.

IV. RESULTS AND DISCUSSION

The goal of the present study is to investigate experimentally the effect of the sand diameter, sand concentration and slurry velocity on the sand-water (two-phase) flow behavior, especially for the pressure drop of the two-phase flow in a circular duct.

A. Pressure Gradient

1) Effect of the sand diameter variation on the two-phase pressure gradient

Figure 2 shows the effect of the mean sand diameter (d) on the frictional pressure gradient (dp/dz) at constant volume concentration values (C). The frictional pressure gradient increases with the increase of the mean mixture velocity (V) at constant concentration values and constant mean sand diameter.

Furthermore, the pressure gradient is increased with increasing the sand diameter at a constant concentration. For sand-water mixture with sand volume concentration $C = 2.5\%$, Fig. 2-a, the pressure gradient is increased for the three different sand diameters ($d = 0.15$, 0.3 and 0.44 mm) than that using pure water only by 4.8%, 5.6% and 7.1%, respectively.

The pressure gradient increases more when larger sand concentrations are used to reach 7.5%, 8% and 8.6% compared to pure water for $C = 5\%$ sand volume concentration, Fig. 2-b, and 8.7%, 10% and 10.8% for $C = 10\%$ sand volume concentration, Fig. 2-c, for the three different sand diameters, respectively.

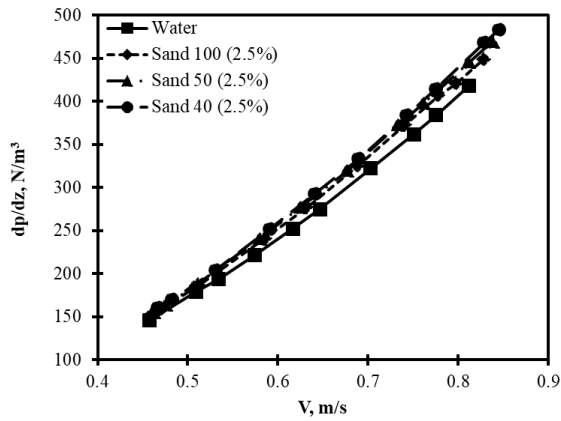

(a) C = 2.5%

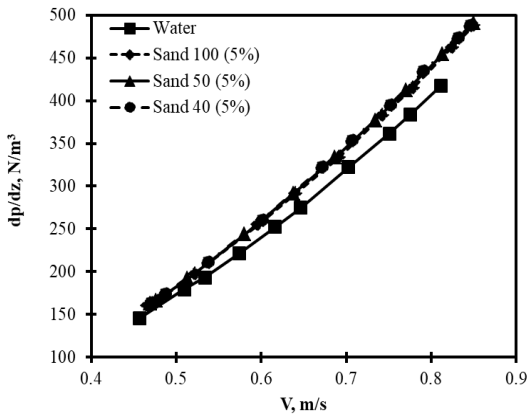

(b) C = 5%

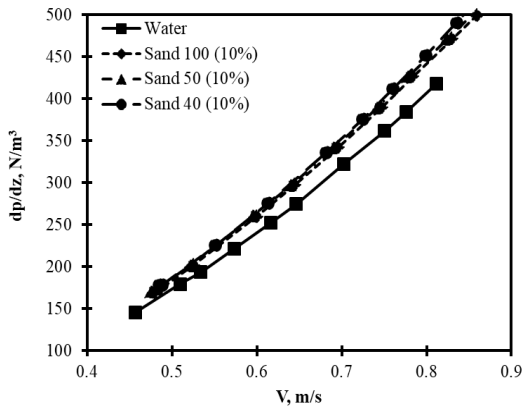

(c) C = 10%

Figure 2 Variation of the pressure gradient with the mixture velocity at constant sand concentration.

2) Effect of the sand concentration variation on the two-phase pressure gradient

Figure 3 shows the effect of the sand diameter (d) on the pressure gradient at constant sand concentration. The pressure gradient increases with the increase of the mean mixture velocity. It can be observed that the lowest sand concentration has the lowest pressure gradient value for all mixture velocities at a constant sand diameter value.

For sand-water mixture using sand 100, Fig. 3-a, the increase in the pressure gradient for C = 2.5% sand

concentration comparing with the pure water was about 4.8%. If the sand concentration increased to C = 5% and 10 %, the pressure gradient is 7.5% and 8.7% higher than the water, respectively.

Also, for sand-water mixture using sand 50, Fig. 3-b, the pressure gradient is increased by 5.6%, 7.8% and 10% compared with that of water for C = 2.5%, 5% and 10%, respectively. The differences in the pressure gradient are increased for the larger sand diameter (sand 40), Fig. 3-c, to reach to 7.1%, 8.6% and 10.8% for sand concentrations C = 2.5%, 5% and 10%, respectively.

The lowest pressure gradient is obtained at sand 100 concentration of C = 2.5% and the highest pressure gradient is obtained at a sand 40 concentration of C = 10%.

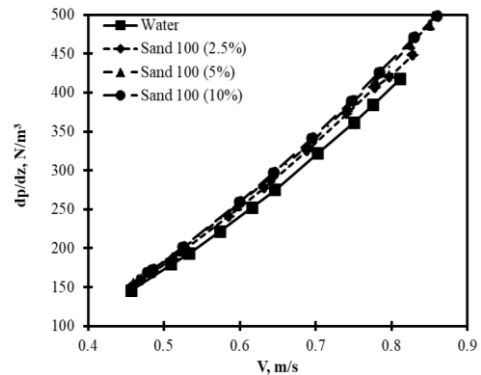

(a) d = 0.15 mm

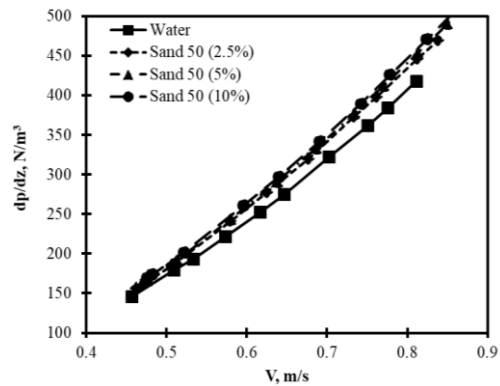

(b) d = 0.3 mm

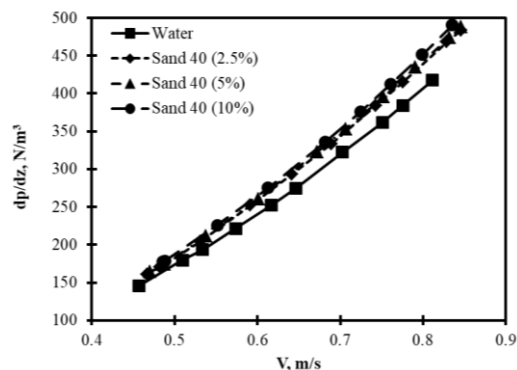

(c) d = 0.44 mm

Figure 3 Variation of the pressure gradient with the mixture velocity at constant sand diameter.

B. Friction Factor

1) Effect of the sand diameter variation on the two-phase friction factor

The general form of the Blasius equation can be expressed in the form;

$$f = \frac{A}{Re^n} \quad (1)$$

Lockhart and Martinelli [15] and Taitel and Dukler [16] proposed the constants of the Blasius equation (A and n) for turbulent flow as 0.046 and 0.2, respectively.

Figure 4 shows the effect of the sand diameter d and the mean Reynolds number ($Re = \frac{\rho_w VD}{\mu}$), at the constant concentration (C) on the friction factor. As shown in Fig. 4, the friction factor (f) increases with increasing the sand diameter for the different concentrations. For sand concentration of C = 2.5%, the friction factor increased by 5.6%, 8.2% and 8.6% compared with that of pure water for the three different diameters (sand 100, sand 50 and sand 40), respectively.

The results of C = 5% and 10% for the three sand diameters are illustrated in Figs. 4-b and 4-c. The increase of the friction factor is 7.9%, 9.3% and 9.7% for C = 5%, and 9.2% and 10.5% and 10.9% for C = 10%, respectively.

The lowest friction factor is obtained at sand 100 with C = 2.5%, whereas the highest friction factor is obtained for sand 40 at C = 10%.

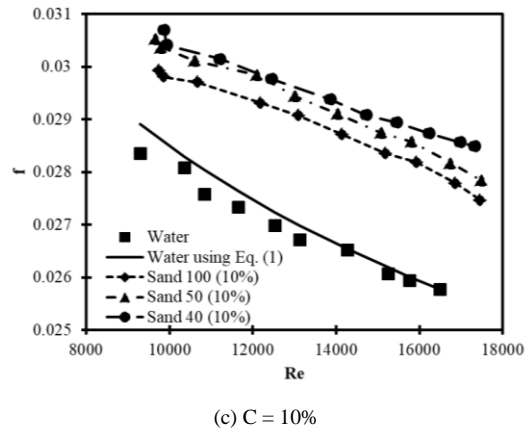
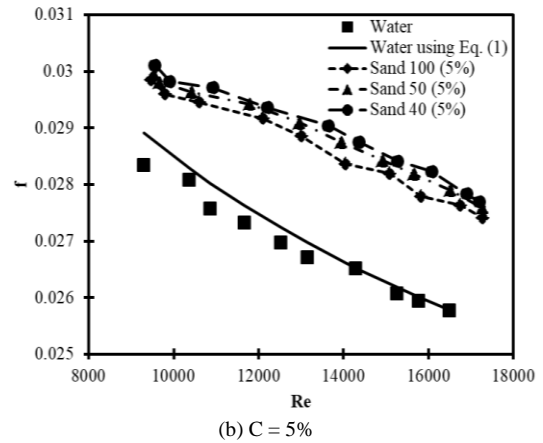
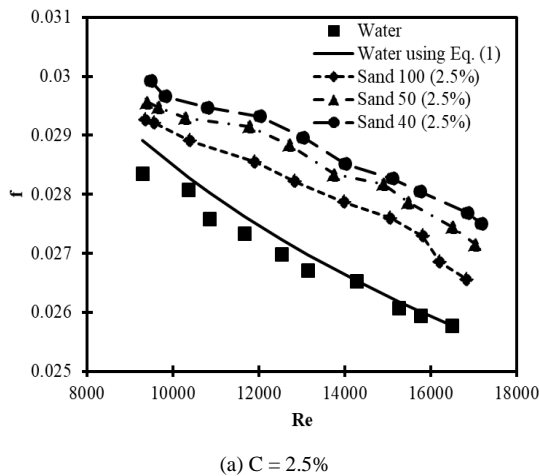

Figure 4 Variation of the friction factor with the Reynolds number at constant sand concentration.

2) Effect of the sand concentration variation on the two-phase friction factor

Figure 5 shows the effect of the sand concentration and mean Reynolds number at a constant diameter on the friction factor.

Figure 5-a presents the friction factor variation for the pure water and sand 100-water mixture at the three different concentrations of sand C = 2.5%, 5% and 10%. The friction factor increased by 5.6%, 7.9% and 9.2%, respectively compared with that of pure water.

Moreover, Fig. 5-b shows the increasing occurred in the friction factor for sand 50 with increasing the sand concentrations (C = 2.5%, 5% and 10%) by 8.2%, 9.3% and 10.5%.

Figure 5-c shows the results of the highest sand diameter (sand 40). Here, the highest percentage of increase in the friction factor than the pure water are equal to 8.6%, 9.7% and 10.9% at the sand concentrations C = 2.5%, 5% and 10%, respectively.

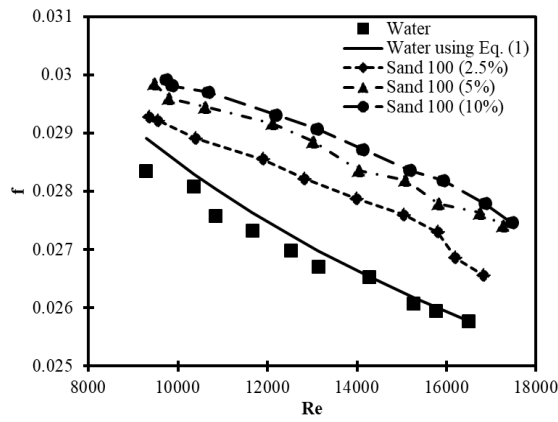

(a) $d = 0.15 \text{ mm}$

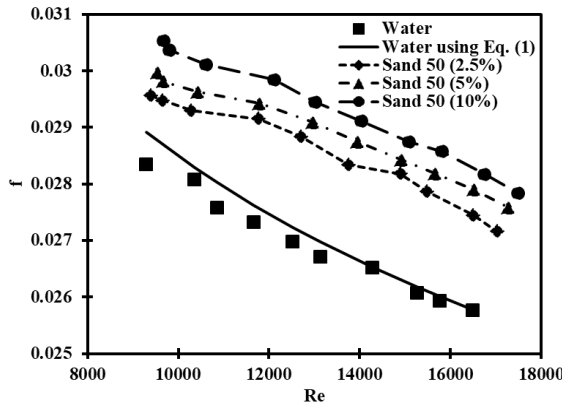

(b) $d = 0.3 \text{ mm}$

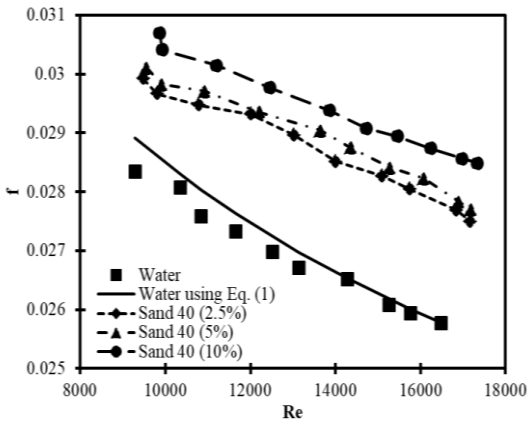

(c) $d = 0.44 \text{ mm}$

Figure 5 Variation of the friction factor with the Reynolds number at constant sand diameter.

C. Hydraulic gradient

The experimental hydraulic gradient ($I = dp/\rho_w gh$) has been calculated and plotted against Froude number ($Fr = \frac{v}{\sqrt{2gD}}$) for sand 50 with sand volume concentrations 2.5% and 5% as shown in Fig. 6.

Furthermore, Eltoukhy [12] proposed a correlation, which is a function of the pipe roughness, sand diameter, sand concentration, and Froude number, to calculate the hydraulic gradient;

$$I = \left(4.2 \left(\frac{k}{d} \right) - 0.018 \right) Fr - \left(4.8 \left(\frac{k}{d} \right) - 0.99 \right) C^2 - \left(14.4 \left(\frac{k}{d} \right) + 0.05 \right) C + 0.013 \tag{2}$$

where k is the pipe roughness.

The hydraulic gradient results obtained from previous correlation are also depicted in Fig. 6. As shown in Fig. 6, Eltoukhy's correlation failed to capture the real behavior of the sand-water flow as the hydraulic gradient is approximately constant with changing the mixture velocity.

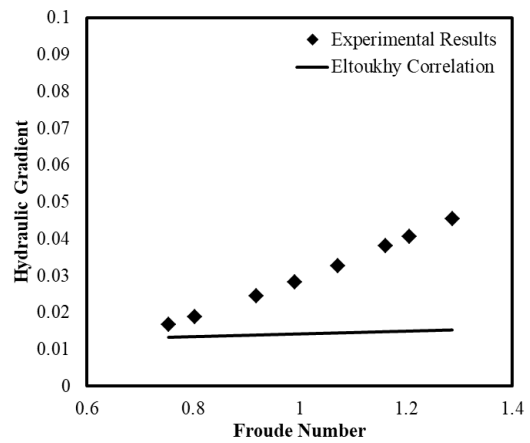

(a) $C = 2.5\%$

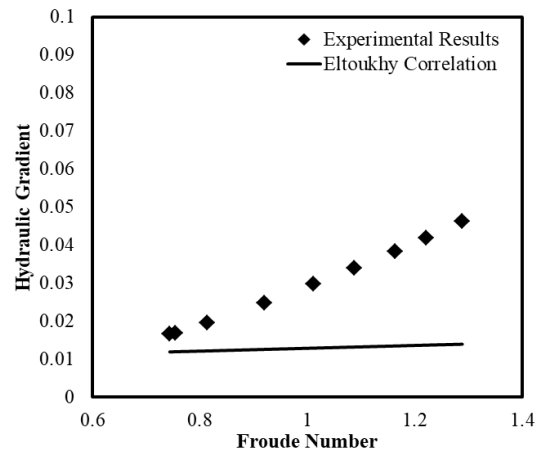

(b) $C = 5\%$

Figure 6 Variation of the Hydraulic gradient with Froude number for sand 50.

Therefore, new correlations for the hydraulic gradient as a function of the sand volume concentration and Froude number are proposed from the present experimental results. These new correlations are concluded for sand 50 and have the following forms;

For $C = 2.5\%$

$$I = 0.053Fr + 1.948C + 1.999C^2 - 0.074 \quad (3)$$

and for $C = 5\%$

$$I = 0.054Fr + 1.946C + 1.999C^2 - 0.127 \quad (4)$$

The results of the new correlations compared with the present experimental results for sand 50 are shown in Fig. (7). It can be observed that the differences between the proposed correlations and the present experimental results are negligible.

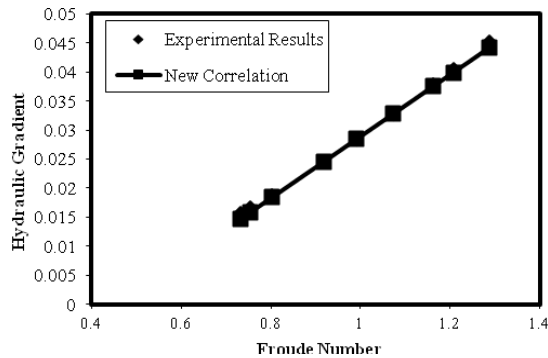

(a) $C = 2.5\%$

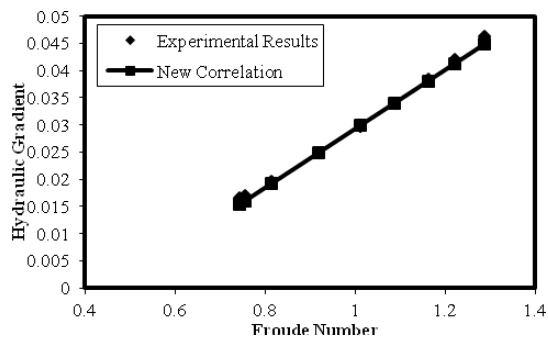

(b) $C = 5\%$

Figure 7 The Hydraulic gradient versus Froude number for sand 50.

V. CONCLUSIONS

The transportation of sand-water slurries is investigated experimentally in a circular pipeline system. The pressure gradient and the friction factor for the two-phase flow are measured and compared with that for pure water only.

The following conclusions have been drawn on the basis of the present study:

1. The pressure gradient increases with the increase of the sand concentration values at a constant mean sand diameter.
2. The pressure gradient increases with increasing the mean sand diameter at a fixed sand concentration value.
3. The experimental friction factor data for pure water concurs well with the data obtained from Blasius equation.
4. The friction factor increases with the increase of the sand concentration values and constant mean sand diameter.
5. The friction factor increases with increasing the mean sand diameter at a fixed sand concentration value.

6. A comparison between the present experimental data of the hydraulic gradient and results obtained from previous correlation was performed. The previous correlation failed to give the accurate hydraulic gradient profile. So, new accurate correlations have been investigated and examined.

NOMENCLATURE

A	Blasius equation parameter
C	Sand volume concentration, %
d	Sand diameter, m
dp	Pressure drop, N/m^2
dp/dz	Pressure gradient, N/m^3
D	Pipe diameter, m
f	Friction coefficient
Fr	Froude number
g	Gravitational acceleration, m^2/s
I	Hydraulic gradient
k	Pipe roughness, m
n	Blasius equation parameter
Re	Reynolds number
V	Mixture velocity, m/s

GREEK LETTERS

μ_w	Dynamic viscosity of water, Pa.s
ρ_w	Density of water, kg/m^3

REFERENCES

- [1] E. J. Wasp, J. P. Kenny, and R. L. Gandhi, "Solid-liquid flow slurry pipeline transportation", Trans Tech Publications. Germany, 1977.
- [2] G. Micale, F. Grisafi, L. Rizzuti, and A. Brucato, "CFD simulation of particle suspension height in stirred vessels", Trans. ICheme, Part A, Chem. Eng. Res. Des., 82(A9), pp. 1204–1213, 2004.
- [3] D. R. Kaushal and Y. Tomita, "Experimental investigation of near-wall lift of coarser particles in slurry pipeline using γ -ray densitometer", Powder Tech., 172, pp. 177–187, 2007.
- [4] C. Kim, M. Lee, and C. Han, "Hydraulic transport of sand-water mixtures in pipelines, Part I. Experiment", Journal of Mechanical Science and Technology, 22, pp. 2534–2541, 2008.
- [5] A. Ochieng, M. S. Onyango and H. K. Kiriamiti, "Experimental measurement and CFD simulation of mixing in a stirred tank: A review", S. A. J. Sci. Tech., 105, pp. 421–426, 2009.
- [6] R. Kasat, A. R. Khopkar, V. V. Ranade, and A. B. Pandit, "CFD simulation of liquid-phase mixing in solid-liquid stirred reactor", Chem. Eng. Sci., 63, pp. 3877–3885, 2008.
- [7] A. Tamburini, A. Cipollina, G. Micale, M. Ciofalo and A. Brucato, "Dense solid-liquid off-bottom suspension dynamics: Simulation and experiment", Chem. Eng. Res. Des., 87(4), pp. 587–597, 2009.
- [8] M. Micheletti, L. Nikiforaki, K. C. Lee, and M. Yianneskis, "Particle concentration and mixing characteristics of moderate-to-dense solid-liquid suspensions", Ind. Eng. Chem. Res., 42, pp. 6236–6249, 2003.
- [9] D. R. Kaushal, T. Thinglas, Y. Tomita, S. Kuchii, and H. Tsukamoto, "CFD modeling for pipeline flow of fine particles at high concentration", Int. J. of Multiphase Flow, 43, pp. 85–100, 2012.
- [10] Y. Faraj and M. Wang, "ERT investigation on horizontal and vertical counter-gravity slurry flow in pipelines", Procedia Engineering, 42, pp. 588–606, 2012.
- [11] T. Nabil, I. El-Sawaf, and K. El-Nahas, "Computational fluid dynamics simulation of the solid-liquid slurry flow in a pipeline", In: Proc. 17th International Water Technologies Conference IWTC17, 5–7 November, Istanbul, Turkey, 2013.

- [12]M. A. R. Eltoukhy, "Hydraulic gradient of sand-water mixture flow for different sands and pipes", *Life Science Journal*, 10 (4), pp. 3490–3495, 2013.
- [13]N. Kumar, M. K. Gopaliya, and D. R. Kaushal, "Experimental investigations and CFD modeling for flow of highly concentrated iron ore slurry through horizontal pipeline", *Particulate Science and Technology*, pp. 1–19, 2018.
- [14]O. Parkash, "Modeling and simulation of sand-water slurry flow", *International Journal of Advance Research and Innovative Ideas in Education (IJARIE)*, 3 (3), pp. 1389–1393, 2017.
- [15]R. W. Lockhart and R. C. Martinelli, "Proposed correlation of data for isothermal two-phase, two component flow in pipes", *Chemical Engineering Progress*, 45 (1), pp. 39–48, 1949.
- [16]Y. Taitel and A. E. Dukler, "A model for predicting flow regime transitions in horizontal and near horizontal gas-liquid flow", *AIChE Journal*, 22 (1), pp. 47–55, 1976.



Mohamed Hassan Mansour was born in Mansoura, Egypt. He received the B.Sc. degree (with honors) in Mechanical Power Engineering from Mansoura University, Mansoura, Egypt, in 2001, the M.Sc. degree in Mechanical Power Engineering from Mansoura University, Mansoura, Egypt, in 2004, and the Ph.D. degree in Engineering Sciences from the Southampton University, Southampton, U.K., in 2010. Since 2010, he has been with the Faculty of Engineering, Mansoura University, where he is currently an Associate Professor. His



current research interests include fluid flow in microchannels, biofluid mechanics applications and two-phase flow.

Mohamed Mahmoud Shamekh was born in Dakahliya, Egypt. He received the B.Sc. degree in Mechanical Power Engineering from Mansoura University, Mansoura, Egypt, in 2004, the High Diploma degree in Mechanical Power Engineering from Mansoura University, Mansoura, Egypt, in 2008, he joined to The Egyptian Natural Gas Company (GASCO) in 2006, his current occupation now is the section head of the pipeline projects construction.



Lotfy Hassan Rabie Sakr was born in Mansoura, Egypt. He received the B.Sc. degree in Mechanical Power Engineering from Cairo University, Cairo, Egypt, in 1973, the M.Sc. degree in Mechanical Power Engineering from Cairo University, Cairo, Egypt, in 1975, and the Ph.D. degree in Engineering Sciences from the Edinburgh University, Edinburgh, Scotland, U.K., in 1978. He became the Section head of the Mechanical Power Engineering at The Faculty of Engineering, Mansoura University from 2008 to 2010.